



Intermediate Coach



The AYSO National Office
TEL: (800) 872-2976
FAX: (310) 525-1155
www.ayso.org

All rights reserved. © 2012 American Youth Soccer Organization

Reproduction in whole or in part is encouraged provided no changes are made to content and the “2012-2013 Intermediate Coach Manual” is referenced.



everyone plays®





Contents

Welcome	7
AYSO Vision & Mission	8
AYSO Vision	8
AYSO Mission	8
AYSO Intermediate Coaching Course	9
AYSO History and Philosophy	10
Qualities of a Coach	12
The Coaching Process	13
Psychological Motivation	14
Motivation	14
Characteristics of Various Age Groups	15
Personality Traits of Successful Athletes	16
Systems of Play	17
Characteristics by Position	18
Soccer Systems	18
Summary	19
Objectives and Principles of Play	20
Coaching Cycle	22
Match Characteristics	22
Elements of Practice – What Is Taught	22
Match Pressure – Controlling the Practice	23
Build-up to Match Conditions – Organizing the Practice	23
Teaching and Coaching Skills	24
Maximizing Coaching Opportunities	25
Summary	26
Team Management	27
Injury Management	29
Injury Management General Guidelines	29



Warm-Up	31
Dribbling	33
Vision	34
Touch	35
Turning	36
Shielding	38
Ball Control	39
Ball Control Skills	40
Control with Pressure	42
Passing	46
Build-up	47
Finishing	50
Build-Up	51
Small-sided game: 2 vs. 1	53
Heading	55
Defending Methods	57
Tactical Objective	57
Delay	57
2 vs. 1 Situations	60
1 vs. 2 (Support or Depth)	61
2 vs. 2	61
3 vs. 3	64
Marking	67
Marking Drills	67
Classic 3-fullback pivoting defense	68
Counter attack training	68
Counter attack from defense	70
Man-to-Man Defense	71
Zone defense	71
Attacking Methods	72
1 vs. 1	72
2 vs. 1	72
Build-up 2 vs. 1	73
Combination Play	74
Wall Pass	74
Wall Pass Build-up	75



Wall Pass Option Training	76
Give-and-Go	77
Build-up Give-and-Go	77
Take Over	81
2 vs. 1 Summary	83
2 vs. 2	84
3 vs. 1	86
3 vs. 2	90
3 vs. 3	92
Restarts	95
Kick-off	95
Throw-in	96
Corner-kicks	97
Build-up	100
Goal-kick	101
Dropped Ball	101
Free-kicks	101
The Wall	102
Direct Kicks	102
Penalty-kicks	103
Indirect Kicks	103
Goalkeeping	105
Role	105
Requirements	105
Technique	105
Positioning	107
Skills Build-up	107
Glossary of Soccer Terms	109
Appendix A: Laws of the Game	111
LAW 1: The Field of Play	111
LAW 2: The Ball	112
LAW 3: The Number of Players	112
LAW 4: The Players' Equipment	112
LAW 5: The Referee	113
LAW 6: The Assistant Referees	113
LAW 7: The Duration of The Match	113
LAW 8: The Start and Restart of Play	114



LAW 9: The Ball In and Out of Play	114
LAW 10: The Method Of Scoring	115
LAW 11: Offside	115
LAW 12: Fouls And Misconduct	116
LAW 13: Free Kicks	117
LAW 14: The Penalty Kick	118
LAW 15: The Throw-In	118
LAW 16: The Goal Kick	119
LAW 17: The Corner Kick	119
Appendix B: Line-Up Sheets	120



Welcome

Most of you reading this are coaches who have completed the AYSO U-12 Coaching Course and want to know more about youth soccer coaching. The AYSO National Coaching Advisory Commission is pleased to prepare this manual to help you continue your soccer coaching education. It is important to remember the philosophy that brings us together. AYSO is a youth soccer organization with the emphasis on the word youth. AYSO is unique because it recognizes the needs of young people by holding to our philosophy: everyone plays, positive coaching, balanced teams, open registration, good sportsmanship and player development. These elements have made AYSO a model for other youth sports groups and have resulted in astounding growth. Our philosophy is reflected in this manual and the course that accompanies it.

We encourage you to use the skills contained here to train your players. However, this manual was not developed to stand alone. In order to understand fully the information that is contained herein you must attend the AYSO Intermediate Coaching Course.

We encourage you to continue your coaching education by attending AYSO coaching clinics in your section. Your area director can provide the information. Again, welcome. We're glad you are continuing your coaching education. On behalf of the players, thank you!

National Coaching Advisory Commission



AYSO Vision & Mission

AYSO Vision

To provide world class youth soccer programs that enrich children's lives.

AYSO Mission

To develop and deliver quality youth soccer programs in a fun, family environment based on the AYSO philosophies:

Everyone Plays

Our goal is for kids to play soccer—so we mandate that every player on every team must play at least half of every game.

Balanced Teams

Each year we form new teams as evenly balanced as possible—because it is fair and more fun when teams of equal ability play.

Open Registration

Our program is open to all children between 4 and 19 years of age who want to register and play soccer. Interest and enthusiasm are the only criteria for playing.

Positive Coaching

Encouragement of player effort provides for greater enjoyment by the players and ultimately leads to better-skilled and better-motivated players.

Good Sportsmanship

We strive to create a safe, fair, fun and positive environment based on mutual respect, rather than a win-at-all-costs attitude, and our program is designed to instill good sportsmanship in every facet of AYSO.

Player Development

We believe that all players should be able to develop their soccer skills and knowledge to the best of their abilities, both individually and as members of a team, in order to maximize their enjoyment of the game.



AYSO Intermediate Coaching Course

Time Schedule

This course is designed for a minimum of 15 hours of instruction. The 15 hours is designed for 4.5 hours of lecture work and 10.5 hours of field work. Remember that the lecture sessions of this course should cover the main points and allow the coach to read the details.

We recommend that you allocate the time for the course as listed below. Emphasize teaching the techniques on the field.

Class	Title	Chapter/Reference	Type	Minutes
1	AYSO History and Philosophy	1	Lecture	15
2	Qualities of a Coach	2	Lecture	15
3	Psychological Motivation	3	Lecture	30
4	Team Management	7	Lecture	30
5	Coaching Cycle	6	Lecture	60
6	Principles of Play	5	Lecture	30
7	Systems of Play	4	Lecture	30
8	Injury Prevention and Warm-up	8	Lecture	30
9	Laws of the Game	Laws of the Game for Coaches	Lecture	30
10	Ball Control Techniques	11	Field	60
11	Dribbling	10	Field	60
12	Passing Techniques	12	Field	60
13	Shooting Techniques	13	Field	45
14	Heading Techniques	14	Field	30
15	Goalkeeping Techniques	18	Field	60
16	Attacking Methods	16	Field	120
17	Defending Methods	15	Field	120
18	Restarts	17	Field	75
			Total Lecture	270 minutes
			Total Field	630 minutes
			Total Course	900 minutes



AYSO History and Philosophy

AYSO was founded in Torrance, California in September 1964. At the time there were few opportunities for youth to play organized soccer. Soccer teams that did exist were usually formed by ethnic groups, and this did not meet the needs of the vast majority of children in southern California.

Ted McLean, Steve Erdos, Bill Hughes, Ralph Acosta, and Hans Stierle became AYSO's first officers, and the first season was started with nine teams of 9 to 12-year-olds.

As an independent program, AYSO set a wider goal to bring soccer to an even broader segment of youth. As a result, the program more than quadrupled to nearly 1,100 players on 72 teams in southern California.

In 1967 AYSO expanded to northern California. Soon word of the organization spread and groups started contacting the AYSO headquarters to get more information about our unique program. Hawaii, Kansas, Michigan, Oregon, and Utah joined in 1974. Arizona, New York, Pennsylvania, Connecticut, Idaho, and Florida established AYSO regions in 1975.

By 1982 AYSO had grown to more than 250,000 players in 28 states. As 1984 began, there were 275,000 players in 33 states, Guam, and Washington, D.C. In 1989 AYSO became a National Affiliate of the United States Soccer Federation and established a direct link to FIFA (the Federation Internationale de Football Association), the international governing body of soccer. This relationship opened the door to many opportunities for AYSO players.

AYSO's philosophies grew out of a deep concern for the well-being of all participants. The principles set forth by the AYSO founders in 1964 still guide the organization today.

- **Everyone Plays:** Our program's goal is for kids to play soccer-so we mandate that every player on every team must play at least half of every game.
- **Balanced Teams:** Each year we form new teams as evenly balanced as possible because it is fair and more fun when teams of equal ability play.
- **Open Registration:** Our program is open to all children between 4_ and 19 years of age who want to register and play soccer. Interest and enthusiasm are the only criteria for playing.
- **Positive Coaching:** Encouragement of player effort provides for greater enjoyment by the players and ultimately leads to better-skilled and better-motivated players.
- **Good Sportsmanship:** We strive to create a positive environment based on mutual respect rather than a win at all costs attitude, and our program is designed to instill good sportsmanship in every facet of AYSO.
- **Player Development:** We believe that all players should be able to develop their soccer skills and knowledge to the best of their abilities, both individually and as members of a team, in order to maximize their enjoyment of the game.

A key element in the AYSO program is fun. The practices and games must be fun for the players, coaches, referees, and parents.

AYSO, which has its headquarters in Torrance, California, believes local flexibility provides the best possible program for young players. And to that end, the AYSO National Office provides a number of services such as:

- PLAYSOCCKER magazine
- eAYSO – Computerized registration of players, coaches, and officials
- Soccer Accident Insurance
- Coaching and Referee programs.

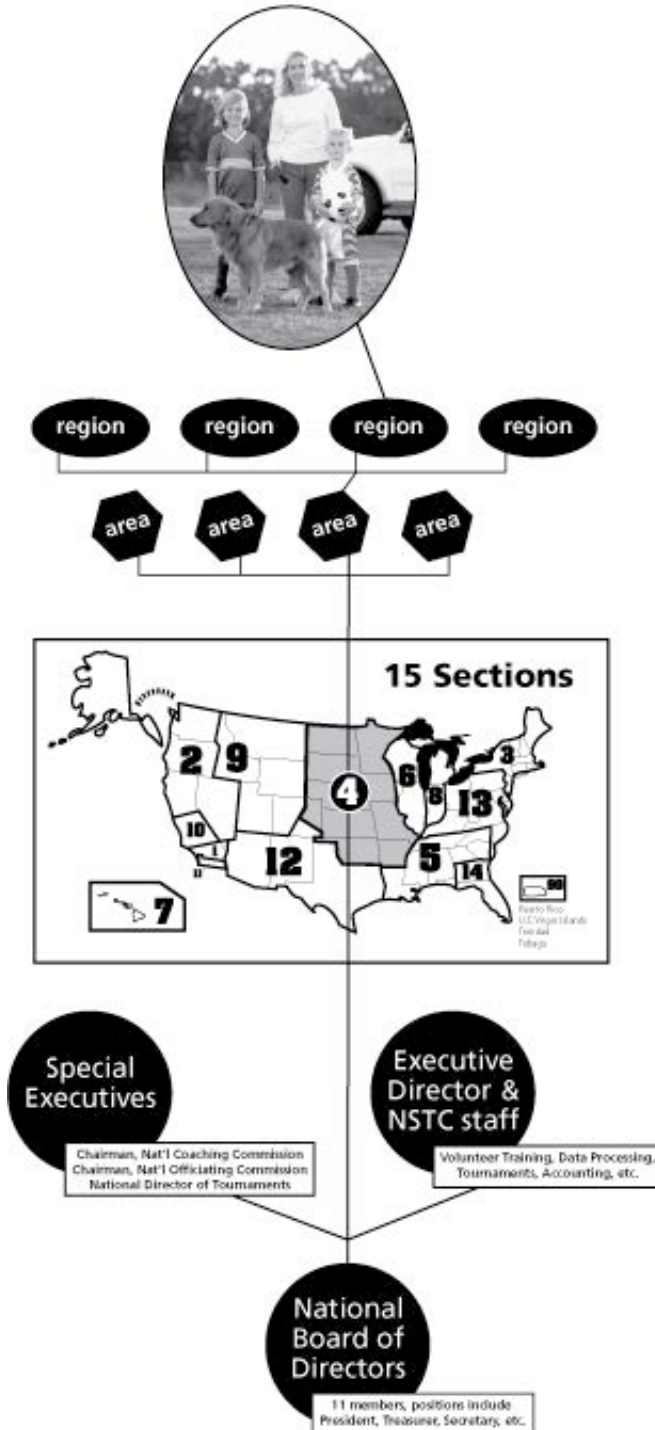

The structure of the AYSO organization is shown by the chart in Figure 1-1. The basic operating unit of the organization is the region. The regional commissioner represents the region as an executive member. Only executive members may vote for the national president, board of directors, and any changes to the National By-Laws or Rules and Regulations. A group of regions comprise an area, which is administered by the area director, who is also an executive member. Areas within a geographic area become part of a section, which is led by a section director. Each executive member gets one vote. The largest number of votes resides with the regional commissioners.

All coaches, referees, regional commissioners, area and section directors, special executives, and members of the board of directors are unpaid volunteers. Only the National Office staff, whose jobs are to provide the services described previously, are paid.

AYSO realizes that each locality has special needs that might require different approaches in organization.

The philosophy and structure of AYSO were created to provide honest competition in which winning kids are more important than winning records. Your help enables AYSO kids to thrive.

Figure 1-1



Qualities of a Coach

Coaching styles differ between individuals because of different personalities and different attitudes toward youth sports. Five different types of coaching styles have been identified:

- hard-nosed or authoritarian coach
- nice guy coach
- intense or driven coach
- easy-going coach
- business-like coach.

All the preceding personality traits can be found in varying combinations and to different degrees in each coach. Additionally, there are different reasons why coaches coach. Three approaches have been identified that characterize why we coach:

- social approach - to promote social interaction among players
- self approach - to gain personal recognition
- task approach - to achieve the team goals.

Once again, the reasons why we coach are made up of various degrees of these attitudes.

Coaching styles differ between individuals. Effective coaches, however, illustrate the same basic qualities:

CHARACTER TRAITS:	SKILLS:
Patience	Manager
Enjoyment	Leader
Responsibility	Teacher
Personal drive	Motivator
Understanding	Uses humor
Conscientiousness	Demonstrator
Positive Role model	Communicator

The important points of the qualities listed above can be combined and called coaching ability. Coaching ability may be described in a concise form by:

- knowledge of the game
- ability to communicate that knowledge
- observation (coaching eye), so a coach may recognize and correct errors in a positive manner.

The Coaching Process

Coaches put their qualities and abilities into practice by following these points:

- planning and adjusting a season as required
- organizing a practice session
- simplifying a complicated skill or tactic to its basic component in language appropriate to the age of the players
- holding players' attention to convey knowledge in a positive manner
- demonstrating skills under game conditions, if possible
- correcting players' actions in a positive manner
- molding players with different levels of skills and knowledge into a functioning unit, with the objective that soccer is a team game
- developing a system or formation of play that is suitable primarily for the team and secondarily for the individual
- changing that system or formation, if need be, for the good of the team
- delegating the necessary administrative duties within the team
- motivating players
- building confidence
- listening to their players.





Psychological Motivation

We talk in our coaching courses about the three elements of soccer that should be incorporated into each practice session. These elements are skills, tactics and conditioning. The psychological development of the player may be added as a fourth element. In fact, player psychology and attitude form the basis for the successful development of the other three elements. It is the coach's responsibility to integrate the following ideas into their coaching:

- develop proper attitude in the players
- develop self-worth by making each player feel important
- make participating enjoyable for the players
- understand player capacities and limitations
- provide proper role model for attitudes and behavior.

The players also have some responsibility in their soccer development with regard to the following:

- Desire
- Dependability
- Dedication
- Determination.

Working together the coach and the player can provide the proper foundation on which to build skills, tactics, and conditioning necessary to be successful.

Motivation

In the coaching cycle, the coach determines what skill or tactic will be taught. During build-up the coach uses incremental steps to develop individual players (or groups). Communicating these steps and providing feedback to players in the form of correction and reinforcement are crucial for obtaining improved performance. Delivered in the proper manner, feedback provides players with a feeling of being rewarded for their efforts. Thus, they are motivated to work harder and perform better.

Because of varying skill levels, a player should be encouraged to compete against oneself instead of peers. Individual goals should be set between coach and player and then work should be directed toward achieving these goals.

Coaches have to deal with both internally and externally motivated players and should work to determine the type of motivation that works for each player.

Motivation Techniques

- Positive reinforcement “opens” the player to further coaching or instruction.
 - Praise the attempt or effort.
 - Correct or reinforce if necessary.
 - Offer further encouragement.

- Do not criticize; always correct or instruct the player in a positive manner.
- Employ the “golden rule.”
- Encourage players to have a positive attitude toward other players. Negative reinforcement by the coach or peers can cause a player to lose self confidence, impairing performance.
- Ask players for their opinions. How do they feel about their skill levels?
- Use good players to assist teammates.
- Avoid favoritism. Give equal attention to all players.
- Set specific standards and goals for individuals, groups, and the team.

Characteristics of Various Age Groups

Motivation techniques should be adapted to the age of the players involved. While the fundamental concepts remain the same, the coach will want to adopt different styles as influenced by the age of the player. Some characteristics to consider are:

9 to 10 year olds

- Affected by both internal and external motivation.
- Growth is fast in a short span so that anxiety can be created by loss of coordination.
- Still enjoy touching, but some will begin to reject it.
- Attention and retention span is slightly increased.
- Emotional response to stimulus is reduced.

11 to 12 year olds

- Mental and physical skills begin to be balanced.
- Strong need for recognition from fellow players.
- Ball skills are being refined.
- Less need for touching.
- Some players begin to drop out and pursue other interests.
- Occasionally display childish behavior and tendency for horseplay.
- Less regard for adult values.
- Differences between male and female players become more pronounced.

13 to 14 year olds

- Period of physical change, accompanied by mental unrest.
- Mostly better players remain.
- Need for strong peer acceptance.
- Desire to improve skills.
- Players become vocal and opinionated.



Personality Traits of Successful Athletes

Research by Dr. Tom Tutko, sports psychologist, has identified certain personality traits that are shared by successful athletes. The coach can, by recognizing these characteristics or their lack in individual players, help team motivation. By building up the individual's less developed characteristics, the coach can help players perform to the best of their ability. These traits are listed below:

Drive

- Great desire to win or be successful
- Concentrated desire toward improvement of weaknesses

Aggression

- Plays hard and stands ground
- Physical, but not violent, play

Coach-ability

- Will take coaching and correction in a positive fashion
- Will perform assigned tasks willingly

Determination

- Player will not give up easily
- Player will work hard to improve

Responsibility

- Will complete assigned tasks
- Does not shift criticism to other players

Conscientiousness

- Attempts to do things correctly
- Does not need constant supervision

Mental toughness

- Can bounce back after error
- Accepts strong criticism

Self-Confidence

- Confident of abilities and knowledge
- Not upset by pressure or surprises

Leadership

- Ability to communicate
- Ability to apply all of the points discussed here

Emotional Control

- Able to control emotion under pressure and adverse conditions
- Not upset by others' mistakes or failings

Trust and Respect

- Ability to trust coach and team members
- Able to trust and believe in oneself



Systems of Play

The evolution of soccer has made it crucial that a soccer coach understand the different Systems of Play to determine which system best fit the team. Simply put, suit a system to available talent. No system will overcome a lack of basic skills. The coach must assess players' mental and physical abilities before choosing a system. The coach must know the team before a system can be chosen.

Players, not team formations, win games. If this were not true, two opposing teams using the same system would always tie. However, two teams that run the same system will emphasize their individual team strengths so that they may play entirely different.

Sad but true, many regions still are playing 11 vs. 11 in the younger divisions. The problem is that younger players do not have the ability to play any system until they are experienced enough to see what is happening in the entire game and to anticipate how play unfolds. If players are unable to hit a ball 20 yards, it is unreasonable to ask them to execute a 30-yard cross. So with young players, don't expect too much too soon, and choose a system that fits the team, not a system that fits the coach.

During the search for a system that fits the team, the coach must remember that flexibility, not regimentation, is the key to choosing a system. When coaching young players, the system will be altered by the ability of the players, style of the coach, and strength of the opposition.

As with principles of play, the coach should complete some basic groundwork for choosing a system of play.

- The coach must think about the field.
- The coach must remember that at each game the team must attack and defend.
- The final question that must be asked is what are the strengths and weaknesses of the players on the team.

Fields: Are they narrow or wide? Are they soft or hard? Are they fast or slow? These are only a few of the questions that each coach should answer concerning fields before choosing a system.

Why ask these questions? First, if the field is narrow, you may not want to run four strikers, it may cause congestion in the attacking area—little chance to penetrate. However, if you are playing defense on a narrow field, you may want to pack it with four defenders.

Each team must attack and defend every time they play: Most goals are scored from inside the scoring zones. The team must look to succeed in scoring zones at both ends of the field.

Strengths and weaknesses of the players: It is important, at the youth level of soccer, that all players are introduced to every position (not in every game). However, when you have chosen a formation, they must understand what will be required from each player at each position. Match your players to the major characteristics required in the different positions.



Characteristics by Position

Defenders

- Goalkeeper: Has agility, sure hands, the courage to pounce on the ball in a congested area, and comes out to challenge breakaways. Also has the ability to distribute the ball and direct the defense.
- Sweeper (roving defender at the back end of some defensive alignments): They are very fast, dependable, and have a better than average understanding of tactics.
- Have sufficient speed to cover opposing players, tackling skills, determination to win the ball, strong leg for goal-kicks, accurate clearing passes, and the ability to head opposition corner-kicks out of danger.
- Be patient and disciplined.

Midfielders

- They have stamina for continuous running and the desire to win the ball.
- They support the offense with accurate passes and long shots on goal, hustle to get back to help defense, while exhibiting strong throw-in techniques, knowledge, and aggressiveness.

Forwards–Front Runners

- Wingers: Speed and ability to cross the ball (pass it accurately into the middle). Wingers should also be able to put corner-kicks into the heart of the penalty-area and be able to create space (running without or off the ball).
- Strikers: They show a strong desire to score and are persistent. They also have good ball handling skills, are powerful, have speed and take an accurate shot.

Remember, no system will overcome a lack of basic skills. The following are a few of the commonly used youth soccer systems.

Soccer Systems

Assume the presence of a goalkeeper and arrangement of the players in three positions: defenders, midfielders, and forwards. The following gives the number of defenders first, followed by midfielders and then forwards.

2-3-5 System

(one of the very first systems to be employed)

- Center midfielder becomes an attacking player.
- Wing midfielders are defenders and attackers.
- Powerful attack, usually one more forward than defender.
- Midfielders must be good defensively.
- Defenders must have a high work-rate capability and must work well with midfielders and other defenders.

3-4-3 System

- Four midfield players given attacking or defensive responsibilities.
- Gives good control of midfield.
- If your opponent uses 4-2-4, then you have one less player on defense than opponent has on offense and vice versa.
- Help is essential from midfield on both attacking and defending.

3-3-4 System

- Common 11-a-side formation.
- Used to attack a 3-defender system.
- Good attacking power and adequate midfield control.
- Midfielder help required on defense.
- Requires good defensive play.

4-2-4 System

- Midfielders - linking attacking and defending must have high work-rate capability.
- Offers great potential for player movement; defender can overlap or support wing play.

4-3-3 System

- Center midfielder must support attack while other midfielders assume defensive coverage.
- Defenders must also assume attacking responsibility.
- Allows good player movement.
- Demands high work-rate in midfield.

4-4-2 System

- Midfield play must be the attacking and defending link.
- Nine plus players can be defensively oriented.
- There are no true wingers.
- Outside midfields move forward to create width.
- Front runners need to be very organized.

Summary

- Remember, suit system to available talent and the physical and environmental conditions.
- No system will overcome a lack of basic skills.
- The coach must assess the players' mental and physical abilities before choosing a system.
- The coach must know the team before a system can be chosen.
- Players, not team formations, win games.
- When playing short sided (fewer than eleven), the principles of these systems can still be employed by simply reducing the members proportionally. For example, a 3-4-3 could become a 2-3-2 for 9-a-side.



Objectives and Principles of Play

What are the “Principles of Play”?

To start with you must not confuse the OBJECTIVES of the game with the Principles of Play:

OBJECTIVES ARE: AMBITION, PURPOSE, INTENT, ENDEAVOR, and the goals you plan to attain...

PRINCIPLES ARE: The MANAGEMENT of play, The LAWS of play, the CONDITIONS of play, The RULES of play.

The principles of play will help you achieve your objectives.

Look at it this way for now. Your playing objective for every game is to score more goals than you give up. How you do that will depend on how strong your principles of play are or how weak your opponent’s principles of play are.

Coaches must UNDERSTAND the “principles of play” if they are to be successful. They are the foundation of all coaching strategy. The Principles of Play are your coaching introduction to tactics.

Youth players (under 19), in general, are not concerned with Principles of Play. Their main interest is in scoring. They want to put the ball in the back of the net more times than the other team.

As a coach you need to help your players understand the Principles of Play so they will appreciate the entire game of soccer. The Principles of Play serve as a set of permanent criteria you can use to evaluate the efforts of your team.

In soccer there are no absolutely correct decisions. And you cannot always judge how well your team is playing by the results. Opponent may be strong or weak. The score most likely will not be an accurate reflection of how well your team is playing. You need to have a standard method of assessing your team from moment to moment. The Principles of Play are your measuring stick.

Attacking Principles / Defending Principles

- There are five attacking and five defending principles of play.
- THE ATTACKING PRINCIPLES ARE: Penetration, Depth, Mobility, Width, Creativity
- THE DEFENDING PRINCIPLES ARE: Delay, Depth, Balance, Concentration, Composure

Attacking Principles in more detail

- Penetration is: Advancement
- Depth is: Supporting teammates (to provide help)
- Width is: Attacking opponents on a broad front.
- Mobility is: During play, the changing of the location of play to provide opportunities for advancement and possession by creating numerical advantage.



- Creativity is: Attacking with elegance, style and flair.

Defending Principles in more detail

- Delay is: Slowing down the attackers until defense is regrouped and can attempt to regain possession.
- Depth is: Supporting the players challenging the ball in case the player is beaten.
- Concentration is: Squeezing the offense into a confined area to make them more predictable.
- Balance is: Providing an equal or greater number of defenders than the offense at the point of attack, simultaneously covering the vital area (near the goal).
- Concentration is: Squeezing the offense into a confined area to make them more predictable.
- Composure is: Defending under control.

There is an ATTACKING PRINCIPLE to counter each DEFENDING PRINCIPLE.

For each attacking principle, there is a defending principle to counter it.	
ATTACKING	countered by DEFENDING
Penetration	Delay
Depth	Depth
Width	Concentration
Mobility	Balance
Creativity	Composure

Attacking/Defending Objectives

Attacking Objectives

- Score
- Advance
- Maintain possession

Defending Objectives

- Stop scoring
- Delay
- Regain possession

Which is the most important game objective? It all depends.

It depends on the relative POSITION of:

- The ball
- The player
- The player's teammates
- His or her opponents

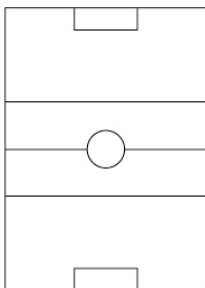

Field Position	Own team with ball	Opponents with ball
Opponent's 3rd	Score Advance Possession	Regain possession Delay
Midfield	Advance Possession	Delay Regain Possession
Own 3rd	Possession Advance	Stop Scoring Regain Possession

When teaching the objectives of Soccer:

- Your first step is to give your players an understanding of the priorities based on field and ball position.

- Remember, these are concepts and young children sometimes have a problem conceptualizing. So do not push concepts, teach them to your players.

Coaching Cycle

Coaching is easier and more fun if a systematic approach to teaching players is adopted. To communicate effectively, it is important that coaches acquire knowledge of the coaching process and the methods utilized to develop players (Figure 6-1).

Match Characteristics

Soccer matches exhibit characteristics of the following:

- shooting
- short play combined with long play
- risk of shooting or advancing vs. the safety of maintaining possession
- transition from attacking to defending, and vice versa (role reversal).

The degree and quality of the above characteristics are reflections of the participants' abilities and degree of understanding of the game. To develop good players, practices should reflect the desired game characteristics. These are achieved by slowly changing the organization of the practice as it builds up to match conditions.

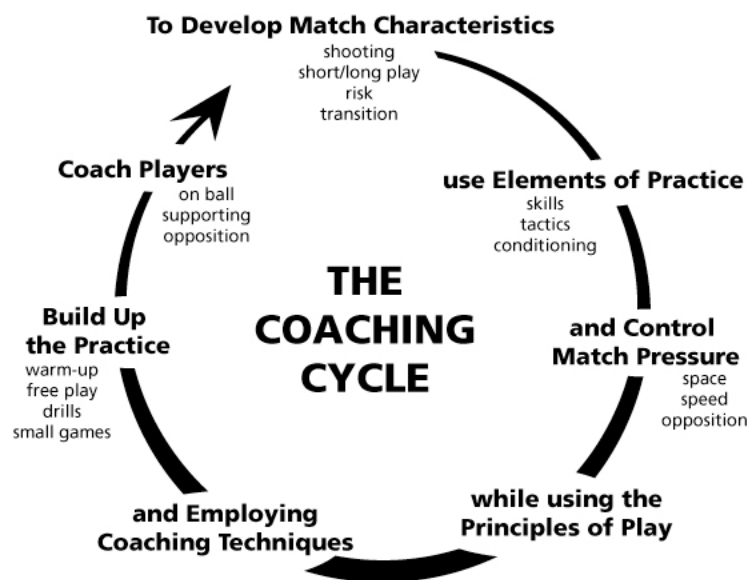

Regardless of what is taught or how it is taught, players should be provided the reason why they are practicing certain elements of the game. Within the limits of their age brackets, players can be provided principles of play that support the game's objectives. These are not taught separately but are integrated into the practice organization. Thus, as the organization of the practice is changed to include more and more match characteristics, players are provided with more of why the game is played in a certain manner.

Elements of Practice – What Is Taught

To play the game, players need the elements of the sport:

- Skills – dribbling, ball control, passing, shooting, heading, tackling, and goalkeeping.

- Tactics – executing the principles of play as an individual, in small groups, and as a team member.
- Conditioning – increasing the body’s ability to expend energy in a more efficient manner.

Practice time is limited, therefore coaches should design practices to integrate all three elements. Avoid drills that emphasize one aspect to the exclusion of the others. The major emphasis for youth, however, should be oriented toward skills-the least emphasis on conditioning. Soccer is primarily a game involving anaerobic alactic (sudden sprints) and aerobic (jogging throughout the game) systems. Conditioning involves training these systems by varying the intensity, duration, volume, and repetition rate of energy expenditure. Tests have shown that for kids in the pre-puberty stage (less than 12 to 14 years old) there is little difference between a highly conditioned player and the normal active youngster.

TIME ENERGY SYSTEM

The energy systems are related to time expenditure as follows:

Maximize the number of opportunities to touch the ball. The coach should avoid long lectures, be positive, and keep things fun.

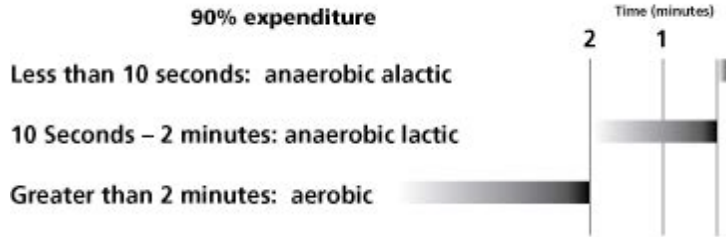

Match Pressure – Controlling the Practice

Practices should simulate as much as possible the pressures players experience during match conditions. The challenge for the coach is how to vary the simulated pressure under controlled conditions. This may be done by doing the following:

- changing the physical SPACE available to the players,
- varying the SPEED of play, and
- varying the amount of OPPOSITION.

Change pressure to meet the players’ capabilities. Start with opportunities for success, then build up pressure to increase the degree of skill or tactical execution.

Build-up to Match Conditions – Organizing the Practice

From the time of the players’ arrival at practice, the coach should seek to gradually build up play to approach that of a match. The process of developing the flow of action in practice, material taught over a whole season, or to the level of play during a match (as the “attack” was built up) is as follows:

Start practices with warm-ups to physically and mentally prepare players for the session.

Create an opportunity to evaluate a player’s ability to execute a certain skill or task. Use free play to observe the player’s capabilities.

- Free play describes the condition where individuals play without restrictions on time or space. Players are given general directions on what they should attempt to accomplish and then are left on their own. The players should play hard and stop for frequent rests. Exploring self and ball allows players to develop natural abilities.
- Free play avoids wasting time organizing lines, capturing wandering kids, etc.



- During free play, players learn to avoid others, seek open space, become more aware of action around them, etc.
- Coaches' observational powers will increase as they are forced to isolate individual action in group movements.

Provide an environment for teaching solutions (options) to match problems. Typical methods include those below:

- Simple motor exercises used to duplicate movements employed by players during execution of a skill.
- A drill requiring organization of the players to repeatedly execute a specific skill or tactic, or combination thereof: Common practice is to start with a "static" drill then progress to a "dynamic" situation. This should be done as quickly as possible.
- Use of a grid, either a square or rectangle with corners defined by some sort of marker (cones or shirts): The coach can put players into manageable groups by varying the number of grids. By varying the dimensions, the amount of match pressure (space, speed of ball) can be changed to meet the player's skill level.
- Pressure drill repetitively testing a player's reflexive action. Pressure comes from execution at a high work-rate. Restrict workload so players' anaerobic alactic systems are not overloaded (generally less than 10 seconds, with two minutes of rest between drills). Exercise extreme caution with younger players.

In summary, coaches should seek high repetition rates in their drills and maximum ball touches in the time allotted. Avoid having players standing around for long periods. During rest intervals try to include some sort of ball work such as juggling, or have the players study their teammates' technique.

Final hint: Don't run a single drill too long. Most players get bored in less than five minutes. If the sequence of drills has been properly selected, however, increasing challenge to the players' skill levels should maintain their interest. Efficient organizations are effective means of communicating knowledge.

Establish a match-type situation so players can use their judgment to apply lessons learned. Generally, this could be some sort of small group game involving the keeping of score and encompassing the characteristics of a match.

While these situations are usually left as unstructured as possible, a game occasionally is restricted or a "condition" is imposed. A "condition game" is employed to emphasize a particular skill or tactic (i.e., control all balls before passing). Lift the condition when the point is made and permit the players to play for fun. Introduce only one condition at a time.

A short-sided scrimmage of 6 vs. 6 is preferable to a full-scale 11-per-side "practice game," with the team sharing the other half of the field. With only 6-a-side, the number of ball touches is doubled, the decision making process is simplified, and the coach has more opportunities to study and correct players' performances.

In summary, the coach must always remember to go from the simple to the complex, communicating in language appropriate to the age of the players.

Teaching and Coaching Skills

During build-up, employ the following presentation techniques:

- Get players' attention.

- State objective. Make a short statement (one or two sentences) on the tactical objective that's geared to the age level of the players.
- Demonstrate. Use key, age-oriented words ("Hit the ball with the shoelaces" for younger ages versus "Keep the ankle locked down and hit the ball with the top of the instep" for older ages).
- Involve player. Repeat demonstration with player(s). If several players are required, build up the positions with specific instructions.
- Involve remaining players.
- Circulate and correct.
- Be positive.
- Use an assistant coach to supervise play and keep the organization running.
- Analyze skills by observing whether:
 - player uses all joints that could be used in proper order (from large to small)
 - player uses strength and impulse flexibility to generate maximum impulse. Start from bent or flex position, straightening joints in correct order.
 - player generates proper direction with body or ball
 - player executes skill from a stable position
 - specific technique is employed as described in the following chapters
 - player exhibits correct use of arms when kicking the ball
- Communicate individual instruction, using concepts of psychological motivation and also by the following:
 - key word usage: specific, not general
 - additional visual demonstration
 - addressing changeable behavior: shoot for small steps that build up overtime
 - constructive (not destructive), positive and informative corrections
 - immediate corrections: don't wait for a later time.
- Always try to give instructions in a positive manner with the players' backs to the sun. Wait for noises to abate and keep instructions short. Try to follow the teaching and coaching techniques for every segment of build-up during the practice session. Avoid excess verbiage.

Maximizing Coaching Opportunities

Keep in mind that coaching is a one-to-one relationship. Unfortunately, the majority of practice time, simply due to the number of players, is spent teaching (one to a group). Therefore, the coach should learn to recognize those opportunities to provide individual instruction. Using the proper organization will also help the coach to maximize these possibilities.

Coach the attack: players with the ball and players off the ball.

Coach the defense: as opposition is built up during drills or short-sided games, take the time to coach the defenders. This is also a way to increase the pressure on attacking players who have learned to solve pressures from uncoordinated or unskilled defenders.

Select the proper player combinations: During skills and tactical training, group players to maximize their development. This does not necessarily mean strong with strong and weak with weak. Frequently, it is more on a personality basis. During ball control, for example, a weaker player could serve a ball by throwing it to a stronger player, while the latter returns a chip. Or two weaker players



might be grouped with a stronger player to provide stiffer opposition, learning to work together as a team. When working in small group games, sometimes a single or pair of weaker players can be rotated in and out of the skilled group, raising their skills without detracting from the level of play. At some point, however, the stronger players will want to work together, and this opportunity should not be denied.

Summary

A coach should use a systematic approach to help in communicating with and training players. Practice is an attempt to duplicate a match in a learning environment. The goal is to build up to match conditions so the play reflects shooting, short and long play, risk, and transition from attacking to defending. To acquire this capability, players are trained using elements of skill development, tactics, and conditioning. The achievement of match pressure while working in these areas can be simulated by controlling space, speed, and opposition. Organize practice to build up to match conditions utilizing exercises, free play, drills, and small-sided games. Each segment of the practice should be communicated in a clear and positive manner. Finally, feedback is provided to players on an individual basis. By following this approach, coaches will find their thoughts are sufficiently organized for them to think on their feet and direct players toward achievable goals. Thus, players will assimilate the material in a rapid and efficient manner.



Team Management

Coaching is a challenging position and can be complicated. As a coach you want to make your life as uncomplicated as you possibly can. Proper team management may not alleviate all your problems, but it can make your life less stressful.

In order to maximize your team potential you must become a chief executive officer (CEO). If you were the CEO of a large company you would need to plan, organize, lead and control. The same can be said for any AYSO coach. Your success as a coach begins with your ability to plan, organize, lead and control.

This chapter is geared towards helping you understand the importance of good team management. Good team management must start with a coaching philosophy. You need to write it down; it is important for you to see what it looks like.

If you have a single word philosophy such as have "FUN," you need to be able to expand on that. How are you going to have fun?

Work on this one. My team philosophy is for each of my players to have fun while they learn basic soccer skills, tactics, and the laws applicable to them, while stressing mental and moral development of each. Players also need to be in proper physical condition appropriate to the age group and level of play.

Putting your philosophy on paper is the easy part. The difficult part is putting on paper how you can accomplish your coaching philosophy. Building your lesson plan to accomplish your philosophy can be simple if you follow a few basic guidelines.

- Make your philosophy attainable. Remember the age group and the skill level of most of the players in the division you are coaching.
- If you are a Division 3 coach, direct your expectations to that level. For example, by the end of the season each player should be able to use heading to clear a ball in the penalty-area. How will this be accomplished?

Example:

- At practice #1, basic heading will be taught (from what book or from whom did you learn the basic heading technique?). At practice #4, directing the ball with the head will be taught (what drill will be used?). At practice #10, power heading will be taught (again what drill will be used?).
- Make a road map to your philosophy. If you do, you will attain it. Remember, the coach is responsible for establishing team goals and for providing the "how to."

A critical aspect of team management is your staff. Remember the coach is the CEO. All CEOs have a staff. You need one. Many youth coaches fall prey to the "I have to do it all myself" syndrome. No, you don't. The benefits of having a staff far outweigh going it alone. If you are a great coach you need to train others. There is always a need for more coaches who have had tutelage from an experienced coach. By having an assistant or two you can do more individual skill work, or work on different aspects of the game. The head coach may be working on finishing, and the assistant may be working on ball control. You need more than assistants - there are other positions you may want to fill.



What about a team manager (Mom or Dad)? This person can take care of your administrative duties: setting up a calling list, ensuring water and ice are at each game, etc. It is important that you get your staff prior to your team and parent meetings. This way the staff can be introduced and their positions and responsibilities explained. The primary benefit from having your staff positions filled prior to your meetings is that you will have interviewed them and they will have bought into and understand your coaching philosophy.

As was discussed in the U-12 Coaching Course, it is important that you have a parent meeting prior to the start of the season. A parent meeting is helpful in transmitting the team goals and coaching philosophy. The meeting also allows the parents to meet the coach in an informal setting.

Policies regarding schedule, equipment needed by players, substitution, players' positions and missed practices and games should be discussed. Players' and parents' behavior toward teammates, opponents, and officials also needs review. Clear policy statements given at the meeting can help avoid problems later in the season.

After you have met with the parents, meet with your players before you ever put a ball on the ground. Explain your team goals and coaching philosophy. Let the players know what behavior is expected of them. Talk about their language, how they are to dress for practice, etc.

Now is the time for you to learn about your players. Talk to your players. Ask them what positions they have played and of their experience. This is called "listing your players." It will assist in your appraisal but should not be the final determination. There is value in having players vary positions from those they played in previous years. Remember, it is only a starting point.

At this point you need to chart your players. Make a chart evaluating and recording the following for each player:

1. Quickness - speed over short distances, speed in taking first steps
2. Agility - ability to change direction, running speeds, and feinting
3. Passing for accuracy - inside of the foot "push" passes
4. Shooting - for accuracy and power
5. Controlling the ball
6. Dribbling and driving - for control and speed (for older players, change of pace and feinting)
7. Heading - as a shot on goal and also as a return pass
8. Aggressiveness (Intensity) - attacking and defending (one on one)

Listing your players will give you a better feeling of what each can and cannot do. Remember, coach, you make the decisions on who plays what position. It is important, however, to keep in mind that your players are learning to play the game, even if they are in Division 3. So, let them play. Involve them in decision-making. Expose them to many positions. Explain the importance of sportsmanship and always keep the game in perspective.

Team management is an aspect of coaching that cannot be overlooked. If you PLAN, ORGANIZE, LEAD and CONTROL your coaching duties, your time as a coach will be less stressful and much more enjoyable. Good team management is a must if you hope to be successful.



Injury Management

Because AYSO is committed to providing a program that benefits youth, preventing injuries must be one of the coach's chief concerns. Many factors influence the number and severity of injuries. Injury prevention can be increased by the following:

- **Proper warm-up:** Unless the body is fully prepared for competition and participation, muscle strains are more likely to result. For younger players, warm-ups create good habits.
- **Sufficient physical conditioning:** While this factor is less applicable to those under 11 years of age, older players will avoid many late game injuries by proper conditioning.
- **Correct soccer techniques:** The techniques used in the game have evolved because they are effective and reduce the risk of injury. Tackling is the most obvious example where an incorrect tackle creates a high risk of injury.
- **Knowledge and application of the Laws of the Game:** The Laws are designed to allow for continuous play with little risk of injury. The "dangerous play" laws deal directly with injury reduction.
- **Sufficient rest and fluids:** Coaching in all sports has come a long way since the days when players were not allowed any rest or fluids during practice. Good coaching and safety require coaches to be reasonable in their practice procedures.
- **Equipment:** Coaches should check that all players are wearing shin guards at games and practices and that all cleats are not dangerous to other players.
- **Maintained facilities:** Coaches should check playing fields and practice areas for unsafe playing conditions. Check for debris, holes, rocks, etc. Do not allow players to play around or upon goal-posts. If unsafe conditions are found, fix or report them to the regional safety director.

Injury Management General Guidelines

In dealing with injuries, the coach must at least look competent and in control of the situation. The coach must remain calm so that the injured player and teammates are not upset.

DO NOT

- try to diagnose a serious injury.
- touch the injury, but ask the injured player to move the affected area.
- A serious injury will not allow movement by the injured player and will give the coach a clue to the seriousness of the injury.

DO

- seek professional help for all but minor injuries.
- put the child's welfare ahead of the team's needs. This is a dilemma all coaches face. AYSO philosophy emphasizes healthy competition in a proper perspective. Playing youngsters with serious injuries is incompatible with the best interests of the children.



Is a player ready to return to play?

- Can the player walk without limping?
- Can the player run in a straight line?
- Can the player cut from side to side?
- Can the player execute other demands of the game?
- Is the player safe from further injury?
- If the answer is no to any of these, do not return player to the game.

Care and Treatment of Injuries or Conditions

Sprain (ankle, knee, wrist, elbow)	Pressure wrap, ice for 20 minutes per hour during first 48 hours. Elevate when possible. Rest Ice Compression Elevation
Muscle strain (pull)	Same as for sprain.
Contusion	Same as for sprain.
Cramp	Apply light pressure with hand. Stretch muscle with steady pressure. Ensure player is well hydrated.
Nose bleed	Direct pressure (pinch nostrils.) Sit player up. Don't blow nose.
Cut or abrasions	Stop bleeding with direct pressure. Wash with antiseptic. Close with adhesive strip or butterfly. Cover with dry sterile dressing.
"Wind knocked out"	Lie on side or back. Encourage slow, relaxed breathing. Try to reduce anxiety.
Heat exhaustion - player feels cool, clammy, and damp	Move to shade. Douse with cool water. Give fluids.
Unconsciousness	Check airway, breathing, and pulse. Don't move (risk of spinal injury). Get help!
Concussion (possible with or without consciousness)	Look for loss of memory, confusion, headache, dilated pupils, nausea. If any doubt, get help. Do not send player back into game.
Choking - object blocking wind passage	Use Heimlich Maneuver.
Fracture/Dislocation	Immobilize area. Get help!
Heat Stroke - player feels hot and dry	Hospital now!



Warm-Up

A proper warm-up before any physical exertion is very important, and yet it's frequently ignored by coaches and players. Warm-up should be the first part of every practice. There are psychological and physical components to the warm-up.

Physical Need

- To prevent injuries. Many of the muscle strains in a game occur in the first few minutes. Often these can be prevented.
- To prepare the body for the stresses experienced during the game. Typically, the game places great demands on the heart and respiratory systems, as well as strength and elasticity of muscles and joints. A good warm-up will duplicate game demands and gradually prepare the body to meet those demands.

Psychological Need

- To bring individuals together and help direct their thoughts and actions toward cooperation and teamwork.
- To develop a habit in younger players so they always warm up properly. Not all coaches are trained in proper coaching methods and players can avoid injury if they know the components of a good warm-up.

Intensity

- The intensity of the warm-up (the length and pace of the activities) are decided by the following factors:
- Age of players: young players (under 12) are less heavily muscled and require a less intense warm-up. Older players require a more extensive period.
- Player fitness level: early in season vs. mid-season or spring start after winter layoff. Early season requires more attention to the warm-up phase.

Sequence

The currently accepted program of pregame/practice warm-up consists of three phases:

- Light exercise: designed to warm up the muscles and raise body temperature while duplicating movements expected to occur during the game/practice. Movements should be gradual and deliberate. Players should use a ball while lightly jogging, passing, heading in pairs, or juggling.
- Static stretching: designed to stretch and loosen the various muscle groups slowly. The word "static" implies stretching exercise performed without vigorous movement. The stretch should be "held" for 15 seconds for younger players and 20-30 seconds for older players. Special emphasis should be placed on thigh muscles, hamstrings, groin, calves, and abdominal muscles. No bouncing.
- Dynamic stretching: allows for a more rigorous stretching of muscle groups. Emphasis here should be placed on demanding, agility-oriented exercises with vigorous movement such as jumping, forward and backward sprints, stop and go, directional changes in a circle, high stepping in place, etc. Again, a ball should be used whenever possible.



Technique

- Relax: The secret to a good warm-up depends greatly on the ability of the player to relax during and after each exercise. To achieve this, it helps to prohibit and avoid talking or “horsing around,” to have players keep their eyes closed, and to “talk through” each exercise. Also allow players to relax or “shake it off” between stretches.
- Sequence: Greater benefit and more enjoyment will be derived by starting your stretches from the toe up, i.e., toe lifts, heel raises, hamstring stretches, thigh extensions, leg lifts for abdomen, etc.
 - For agility exercises with ball, the same sequence will be beneficial, i.e., juggling, bend over figure eight between legs, circle around waist, etc.
 - Moving into or out of a stretch should be done slowly. Stretch to point of resistance - not until muscle vibrates. Don't bounce in a stretch. Hold 15-30 seconds. Relax.
 - The dynamic phase should include a dribble, quick dribble, sprint dribble, slow dribble with turns, slow dribble with stop and go, slow dribble with jumps, slow dribble with multiple successive jumps, etc.

Leadership

Alternate your warm-up leaders. Inform leaders ahead of time so they may prepare. Observe and make positive comments to your players.

Coaching Points to Remember for Warm-ups

- Pick a warm-up leader in advance.
- Give the leader some hints (especially young players) but allow for creativity/selection.
- Don't permit “horsing around,” but keep the atmosphere light.
- Players should not face sun.
- Use a shady spot on a hot day.
- Walk around, participate, encourage.
- Have players keep eyes closed during stretching.
- Verbally recognize improvement to motivate players.
- Push players, especially during dynamic phase, but keep eyes on players for over exertion.
- Vary warm-up sequence at practice throughout the year.
- Develop a formal pregame warm-up.

Dribbling

The sight of a player using dribbling skills to beat an opponent and score a well-earned goal is one of the most exciting plays in soccer. Many people view dribbling as an art or talent that a player is born with, but it is a skill that can be acquired and improved. What is difficult to develop in a player is creativity. Creativity is what separates a good dribbler from a great one. Players have different dribbling styles. Some run with long strides, some with short, choppy steps. Players have their own style, and it is up to the coach to help each player develop to their potential.

Dribbling by its very nature involves pressure of an opponent. We would like to distinguish between the dribbling movement - characterized by close control, touching the ball almost every step while under pressure of an opponent - and driving - the act of a player running with the ball without opposition, taking long strides, pushing the ball ahead, and running after it. Dribbling is performed using all the surfaces of the foot: top, bottom, inside, and outside. To dribble, a player does not kick the ball but rather the ball is pushed, nudged and caressed. Young players need to become comfortable with the ball using all the surfaces of the foot.

In order to develop players skilled at dribbling, coaches need to understand the why and where of dribbling. Players dribble to maintain possession of, or to advance, the ball. When a player is unchallenged, the ball should be dribbled forward immediately. Players under pressure dribble to maintain possession while looking for passing opportunities. Players should avoid all risks in the defensive third of the field by foregoing the dribbling option and choosing to pass the ball up the field. Dribbling in the attacking third of the field to gain an opportunity for a shot is well worth the risk. Players moving in the middle third of the field must weigh the advantage of quicker advancement by using passes. The key item in learning where and when to dribble is decision making. In tactical training situations, the coach should stress proper decision making by the player with the ball relative to the positions of the ball on the field and supporting teammates.

The discussion of the technical points of dribbling will be broken into five parts. These parts are:

- vision
- touch
- turning
- beating a defender
- shielding

Vision

It is important that dribbling players be aware of their surroundings. Knowing the position of supporting teammates and defending players is important information when a decision is required. Coaches need to make players aware of proper eye positioning. The dribbling player should focus on the opponent's waist. The ball should be visible to the dribbler just inside the lower part of the vertical peripheral vision. This allows the dribbler to see the opponent and the ball at the same time. (See Figure 10-1) We can train for proper eye positioning by using the following exercises.

- Players place ball at feet, facing coach who is stationed 10-15 yards away.
- Players look down at the ball and raise head until they can see coach and ball. Head and eyes are fixed, not moving. Coach checks focus point of each individual.
- Players juggle ball back and forth, watching the coach. Players call "up" or "down" as coach raises or lowers hands. Raise hands from below waist to middle of chest. Do not raise overhead. Coach critiques eyes and head position.
- Coach backs up slowly, players advancing and calling as in (3) above.
- In pairs, players coach each other as in (4) above. Advanced variation: player with ball chases retreating partner 10-15 yards ahead. When partner raises hands, ball is passed and players switch roles.
- Combine eye with touch control. Repeat (5) above, but player retreats only 2-3 yards in advance of dribbler. Steal ball if hit too hard.

Many soccer books have drills or exercises that show players dribbling in/out between cones. These types of drills promote head down soccer and should be avoided.

When you attack an opponent with a move, you should be able to see the player and the ball. Keep the ball just inside your peripheral vision. Don't let your eyes shift downward - keep your focus point ahead. Practice this first during your side-to-side juggle.

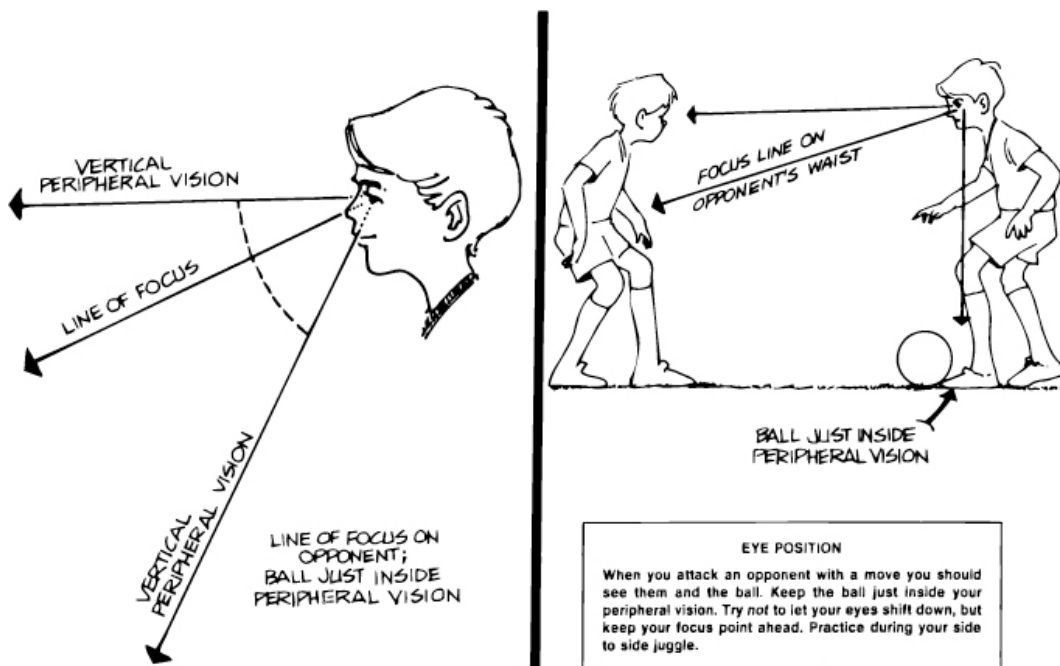

Touch

The development of dribbling touch is essential if players are to develop the close control, balance, and flexibility required for modern attacking soccer. There has been a renewed interest in developing touch spurred by the efforts of Wiel Coerver. Coerver's books and videos have motivated many coaches and players to improve their touch. Improved touch will also benefit the player's ball control.

Touch can be developed by performing exercises with a ball during warm-up. A series of exercises to develop touch can include the following:

- With a stationary ball, each player hops, touching top of ball with sole of foot, alternate touch left/right.
- With a stationary ball, each player hops while moving around the ball, touching the top of the ball with sole of foot. Alternate touch left/right.
- Side-to-side juggle as shown in the figure.
- Box-the-ball juggle as shown in the figure.
- Roll ball using sole of foot. Move sideways to the left using the sole of the right foot. Move ball to the right using the left foot.
- Hop backwards while pulling the ball backwards using the sole of the foot. Be sure to perform exercise using alternate feet.
- Dribble free in practice area. Player uses specific part of foot as specified by coach. Examples: outside of right foot only, inside of right foot only, alternate inside/outside.
- Alternate feet.

The figure on the following page gives examples from an AYSO publication (1000 Minutes).

SIDE-TO-SIDE JUGGLE

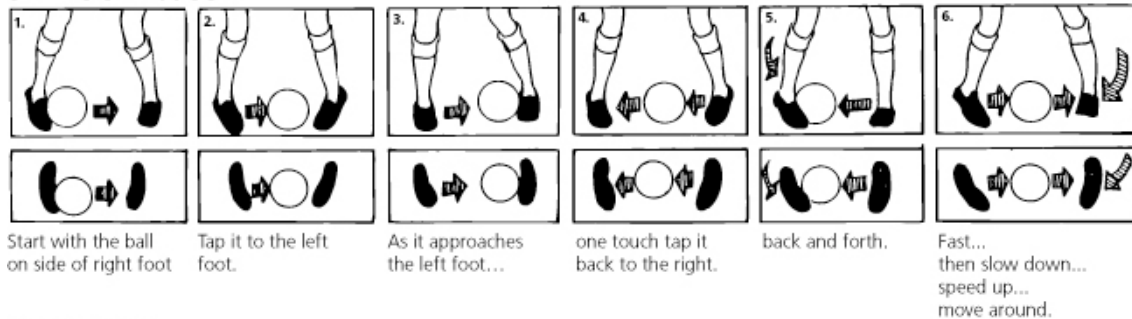

BOX THE BALL

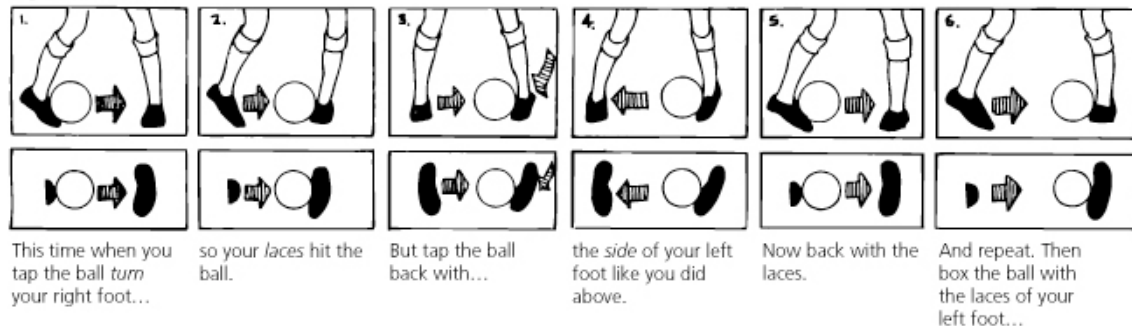

Use the Side-To-Side Juggle and Box the Ball exercises

These will improve your feel and touch for the ball and improve your flexibility. As you gain control over the ball, try to move around, keeping your head up as much as possible. See the other chart on eye focusing. You should just be able to see the ball while focusing on a spot 6-8 feet ahead of you.

Turning

Turning or an abrupt change of direction when dribbling is a skill that all good dribblers must possess. The turn may be used to go around an opponent, to move into open space, or to maintain possession of the ball. This is usually accomplished by players executing turning movement or “moves” with the ball. Players should have their own favorite moves when faced with an opponent in front, to the side, or behind them. It is not the intent of this text to teach all of the possible moves a player might need, however there are other sources available to do just that. A list of available reference materials is presented at the end of the text.

There are several key points to make when utilizing any turning move.

- Incorporate a feint/fake to unbalance the opponent.
- Employ a change of speed from moderate/slow during the move to an explosive burst at the end.
- Utilize a shielding action of the ball, if possible.

A sample teaching progression for a particular turn or move (inside of foot) takes the following form:

Motor Movement

- Utilizing a stationary ball, practice motor movement of the turn (strive for perfection).
- Execute the move while moving slowly with the ball.

Turning and Acceleration (Group Instruction)

1. Players line up with balls. Leader is stationed centrally 10-15 yards in front of the line.
2. Leader or coach demonstrates advancing ball, then reversing direction with the inside of the foot turn. Execute with a swift chop motion. Coach observes and corrects from behind line.
3. On command, players advance following leader. On command, leader and players turn. Coach observes. Advanced variation: leader turns at will, forcing other players to exercise proper eye position and control.
4. Variation: players dribble in circle with coach in center. On command, turn is made, always away from coach, thus exercising both feet. Coach also can apply pressure.
5. Introduce outside of foot turn.
6. As players learn turns, they may be alternated and motor movement restriction by coach relaxed.
7. As turns are mastered, players should be taught to explode 1-2 steps immediately after turn is made, then bring ball back under control.

Turning and Acceleration (Individual Instruction)

1. Players form a 10-yard square with two to four players on each corner, one cone in the center of the square.
2. Players dribble to center cone and reverse direction by using an “inside of the foot” turn. Each player in line executes with “good” foot to ensure early success. After two or three tries, change. “Explode” as turn is finished.
3. Repeat with outside of the foot turn.
4. Pace is generally slow enough to pull player out for minor demonstration of correct maneuver.

4. Beating an Opponent

Effective attacking players must have the ability to beat an opponent when dribbling in the attacking third of the field. There are several key points to make when instructing players on how to beat an opponent.

- Keep it simple.
- Attack front foot of defender.
- Incorporate a feint/fake with a change of direction to unbalance opponent.
- Try to cut the ball toward the back of the opponent.
- Employ a change of pace from slow/moderate during the move to an explosive burst at the end.
- If the opponent is retreating then attack at speed.

The best way to learn how to beat an opponent is to play 1 vs. 1.

1. Lay out a 10-yard square marked with cones. Defender stands in middle of square. Attacker starts at one end and tries to dribble ball past defender and stop it on the end-line.
2. Lay out a rectangular area with two target (T) areas as shown in Figure 10-3. The attacker tries to dribble the ball past the defender and stop the ball in the target zone. The target zone might be hula hoops, cut up garden hose, or marked by cones.
3. Players. Two players play 1 vs. 1 while the remaining two stand ten yards apart with their legs spread, acting as goals. Play for two minutes then switch resting players with field players.

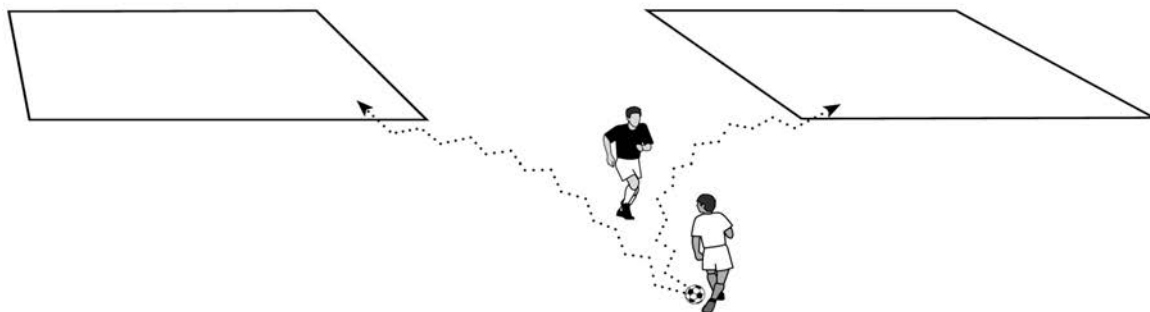
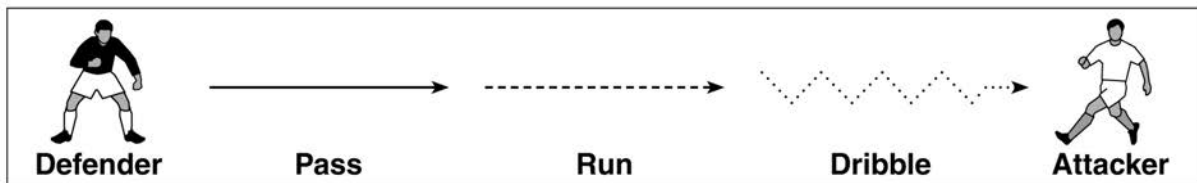

Shielding

Players must learn to maintain possession of the ball under the challenge of an opponent. Players must develop the attitude that no single player can take the ball away. Shielding the ball from an opponent is accomplished by keeping the player's body between the opponent and the ball. The player in possession turns a shoulder toward the chest of the defender. The ball is controlled with the foot farthest from the opponent. The player in possession should be balanced, arms out, with the knees bent, lowering the body's center of gravity. An example of a build-up for screening (shielding) is given below.

Warm-ups

1. Practice stepping on ball, alternating feet.
2. Working in pairs, players jog together, bumping shoulders.

Skill Builder (Motor Movements)

1. Players line up, each with a ball, facing the coach. Repeat warm-up exercise above.
2. Players pull ball backwards, alternating feet. Retreat 10-20 yards, turn around and return.
3. Mid-season alternative: Players place foot sideways on top of ball. Ball is pulled (rolled) forward with sole of foot. Alternate feet.
4. Mix forward and backward motion.

Free Play

1. Demonstrate screening points.
2. Body between ball and opponent
3. Ball on far foot
4. Shoulder pointed toward opponent
5. Play free - players alternate roles.

Restrict space

1. Place players inside grids of 10 yards x 10 yards
2. Players with ball must shield, staying inside square as coach counts to ten.
3. Demonstrate distance that player can run during ten count.
4. Increase difficulty by adding a third player who can enter grid for takeover (see "Attacking Methods") and repeat ten count.
5. Set team goal for each player to achieve, i.e., ten count against every other player on the team.

Advancing Ball (Opposition)

1. Players repeat warm-up exercise, running down touch-line while bumping shoulders.
2. Repeat with one player dribbling ball on foot away from defender. Defender maintains shoulder-to-shoulder contact.
3. Dribbler varies speed with defender alongside, slows, then speeds up to cut in front of defender.
4. Repeat (3) above, adding goal and goalkeeper. Object is to shield ball at speed until close enough to shoot.
5. Set up "A" and "B" lines of 4-6 players, each spaced 15-20 yards apart. First player at the head of line "A" dribbles a ball toward line "B." Defender from line "B" advances toward player with ball. Dribbler shows ball to defender and, by shielding, pulls him around in circle. Defender ends up behind dribbler as latter "explodes" toward line "B." Defender takes place at end of line "A." Repeat.



Ball Control

The ability to control the ball and maintain possession under pressure is a most important skill in soccer. Without close control of the ball, the other skills such as shooting and passing become more difficult. Good soccer begins with good ball control and good ball control is based on the first controlling touch. As coaches, we would like to view the act of controlling the ball as the beginning part of the next move. This means that in training our players, we should strive to have them control the ball and position it for the next move with the first touch. Good control on the first touch will be required at higher levels of soccer.

In simple terms, the tactical objective of ball control is to receive the ball and maintain possession for the next move. There are numerous ways of controlling a ball, but no matter what controlling surface is used, certain technical points are the same.

- Maintain eye contact with the ball.
- Move into the line of flight of the ball.
- Arms are in a comfortable position for balance.
- Body is in a relaxed and balanced position.
- Ball is cushioned on contact utilizing proper technique.
- Prepare ball for the next move.

In order to effectively teach ball control, we utilize the concept of build-up. A sample build-up follows. Many of the build-ups used in the sections on passing and attacking methods may be used to supplement the material presented here for teaching ball control. Remember, the coach controls the teaching emphasis of each activity.

Static drills are used for teaching and checking proper technique.

1. Players are paired opposite each other to avoid setting up lines. Each pair should have their own ball.
2. Ball is thrown or kicked to partner, who controls using inside of the foot. For higher balls use the top of the thigh.
3. Coach should look for proper technique, make corrections when appropriate, and then quickly move on.

Dynamic drills are used to introduce movement into the teaching progression. Movement is always present in the game situation. Repeat the static drills with players moving forward, backward and sideways. Always encourage the use of proper technique.

Repeat the dynamic drill with pressure. Serving player kicks or throws ball, then challenges receiving player who must control and shield the ball to avoid challenge. Several examples are given below,



Ball Control Skills

Sole of foot (ground ball)

- Support leg is slightly bent at the knee.
- Controlling leg is raised from the hip with knee slightly bent.
- Foot is aligned with path of the ball; toe raised and heel down forming a wedge.
- As ball arrives, wedge the ball between sole of foot and the ground.
- Do not step on top of the ball.

Inside of the foot (ground ball)

- Controlling leg is turned outward at the hip with knee slightly bent.
- Support leg is slightly bent at the knee.
- Foot is turned outward so that inside of foot is directed toward path of the ball.
- Foot, with toe raised, is offered toward ball and is withdrawn upon contact with the ball.
- Inside of foot should contact top half of ball.
- Ball should remain close.

Top of instep (air ball)

- Support leg is bent at knee.
- Lift controlling leg from hip with knee bent.
- Height of receiving foot from ground depends on flight of ball.
- Receiving foot is relaxed.
- Ball taken on laces near the toes.
- Foot is withdrawn on impact.
- Ball should remain close.

Inside of foot/Drag control (ground or air ball)

- Support leg is slightly bent at knee.
- Upper body leans slightly backward.
- Controlling foot swings across front of support leg.
- Foot is turned inward at knee.
- Cushion ball with inside of foot and drag across body in a single motion.
- Ball should remain close.

Wedge (air ball)

- Controlling leg is turned outward at the hip with knee slightly bent.
- Foot is turned outward so that inside of foot is directed toward path of ball.
- Support leg with knee bent is located ahead of ground contact point.
- Ball is allowed to contact ground.
- Inside surface of controlling foot makes a roof over ball at time of contact.



- Withdraw leg at the hip.
- Ball should remain close.

Top of thigh (air ball)

- Support leg is bent at the knee.
- Controlling leg is raised from hip with the knee bent to a position near 60° measured from the support leg. This angle can change depending on the flight of the ball.
- As ball makes contact, withdraw thigh and let ball drop to ground.
- Ball should remain close.

Inside of the thigh (air ball)

- Controlling leg is turned outward at the hip with knee slightly bent.
- Support leg is slightly bent at the knee.
- Contact with the thigh is made between hip and knee.
- Thigh is offered toward ball and is withdrawn on contact with ball.
- Ball should remain close.

Stomach (bouncing ball)

- Body is directly in line of flight of bouncing ball.
- Lean body over ball to drive it to ground.
- Allow room for ball to bounce to stomach level.
- Ball should remain close.

Chest (air ball)

- Arching ball.
- Both knees are slightly bent - body is balanced, arms out.
- Hips are forward and chest back.
- As ball makes contact with chest, cushion by flexing knees and relaxing upper body.
- Allow ball to drop to ground.
- Ball should remain close.

Chest (driven ball)

- Body leans forward - body is balanced, arms out.
- Hips are back and chest out.
- Upper body is over ball at time of contact.
- Ball is driven to ground.
- Ball should remain close.

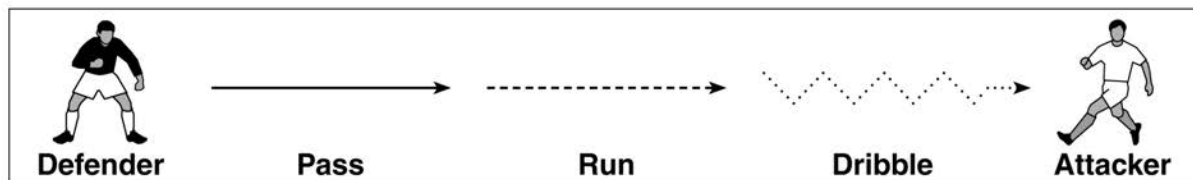

Control with Pressure

3 Players - 1 Ball

- A passes to B
- C pressures B while B must control and turn to shield ball from C
- Alternate player roles
- Vary type of service from A to B

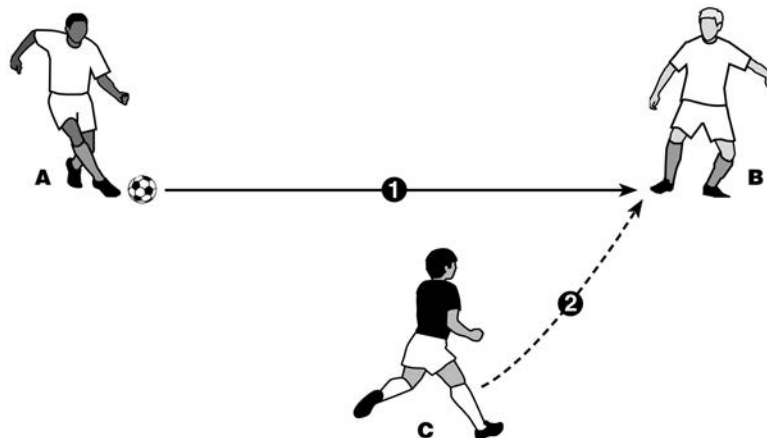

3 Players - 1 Ball

- A passes to B
- B controls and passes to C
- A tries to intercept pass or tackle B before pass is made
- Vary type of service

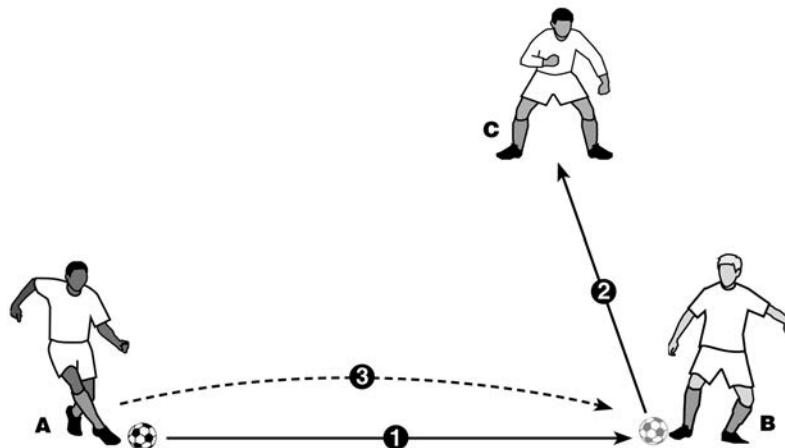

4 Players - 1 Ball

- A passes to B
- B controls and passes to either C or D depending upon action of A
- Vary type of service

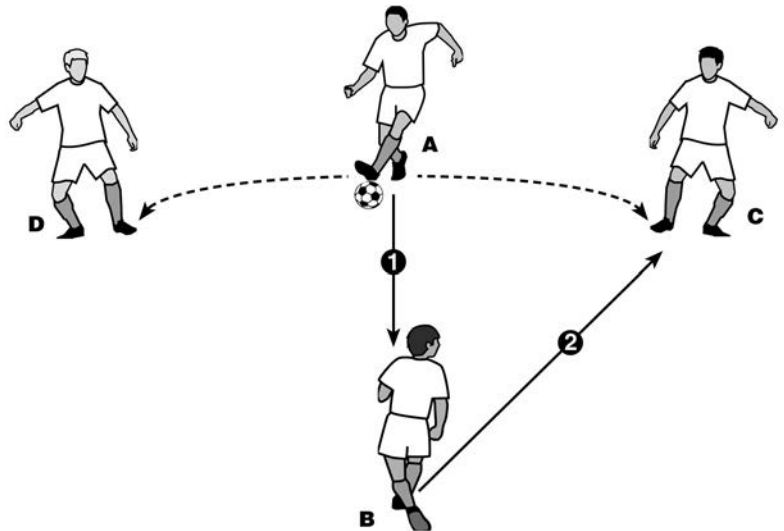

3 Players - 1 Ball

- A passes to B and applies pressure
- B controls ball and turns
- B passes to C
- Vary type of service

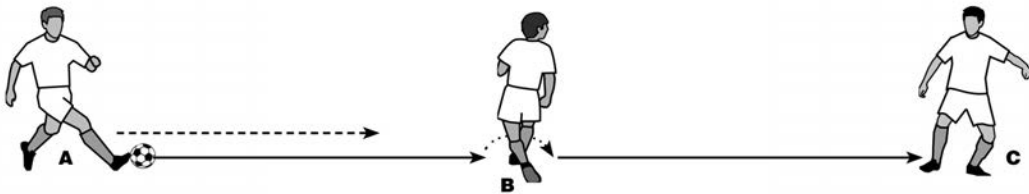

4 Players - 1 Ball

- B checks in/out against C
- A passes to B, who controls and passes to D before A can defend

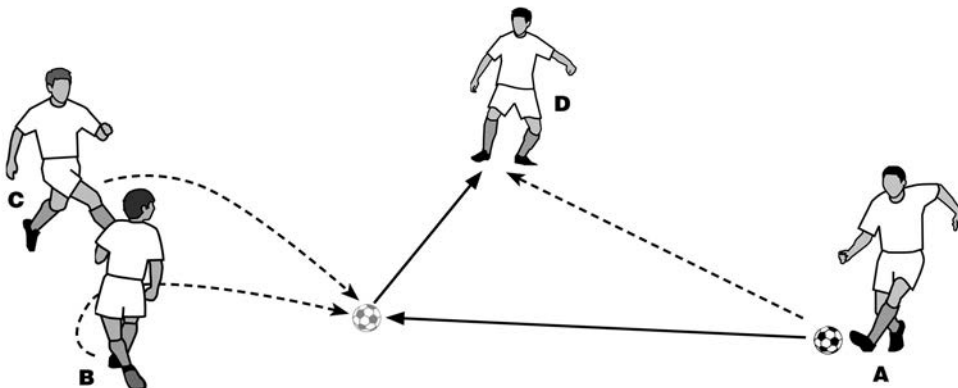

Employ a pressure drill after players master several different controlling techniques. Since this type of drill is highly aerobic, limit time of the drill to 30 seconds for older players. Arrange 6-8 players, each with a ball, to form a large circle. A ball is served to X by player #1, then controlled by X and passed back to #1. As soon as the ball is passed back, X turns to control service from #2. The service from #2 should occur just as X finishes the pass to #1. Service is continuous around the circle. The type of service should be varied (air or ground so player must select appropriate technique to use).

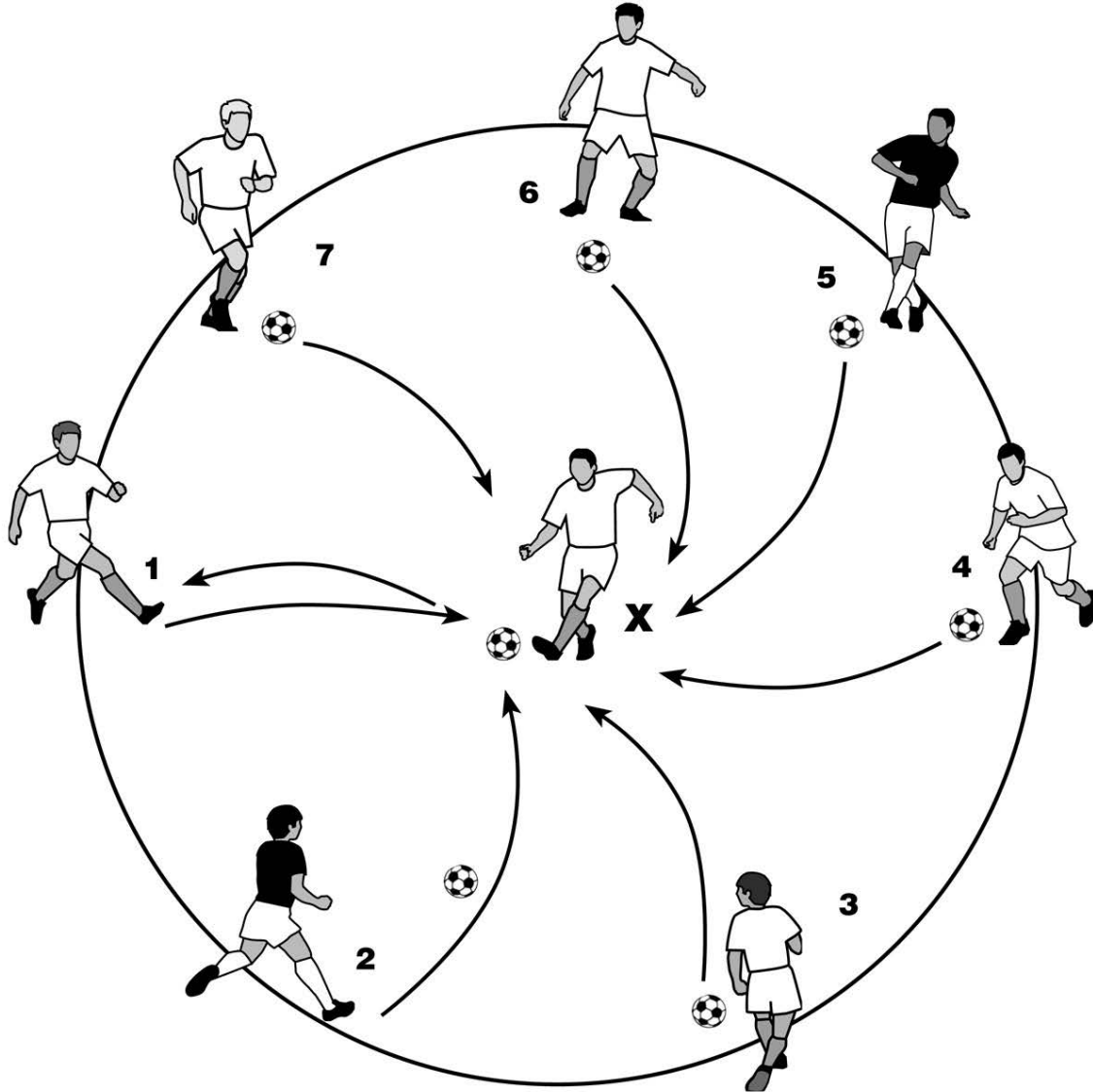

Controlling and Turning Drill Using Three Players:

First player serves to player in middle who controls ball using the inside of the foot and turns to pass the ball to the third player. Introduce a fourth player to pressure player in the middle. Server must now pinpoint pass to side of receiver opposite the opponent.

Repeat drill without defending player, but player receiving the ball must feint to one side, control ball and turn the other way.

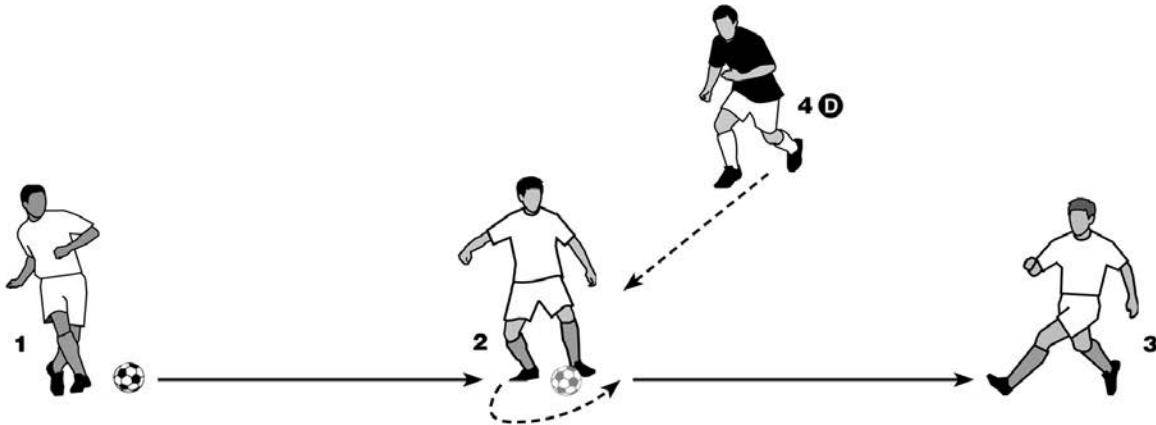

Integrate Ball Control Skills with Passing Drills.

Develop touch during rest periods by juggling singly or in pairs. In pairs, server passes ball on the ground, receiver controls the ball by letting ball run up foot, juggle once and then pass back on the ground.

Develop touch for balls in flight by controlling ball in the air and returning before ball falls to the ground.

Utilize a conditioned game during scrimmages. Players must control ball before passing or dribbling. One-touch play is not allowed. The added condition of lofted passes will get the ball into the air for practice on controlling air balls.

For younger players, allow them to master the basic idea before introducing different techniques with the same part of the body. For example, do not introduce side of foot and sole of foot techniques in the same session.

Always encourage players to use the controlling touch to establish their next move.

Passing

Accurate passing under match pressure conditions is a skill that players should begin to master between the ages of 8 and 12. Good players and good teams are capable of playing an accurate, effective short passing game to create scoring opportunities or to maintain possession of the ball. At the younger ages, emphasis should be placed on mastering the techniques of the instep drive, the push pass, and the outside of the foot pass. Older players within this age group need to utilize longer passes, crosses, etc., and therefore need to learn the technique for the lofted ball and the chip. Not only is proper passing technique important but the player must learn to choose the type of pass best suited for a particular situation. In order to assist the player in making these decisions, the coach should know the five characteristics of a good pass. They are

1. accurate
2. of correct pace (speed or weight)
3. well timed (delivered at appropriate time)
4. deceptive
5. successful in advancing the ball or maintaining possession.

Passing requires coordination of two players - a passer and a receiver. It is this coordination that is hard to achieve with young players. Coaches refer to this coordination as “teamwork.” Players who pass are referred to as “team players.” In order to have good team play, coaches often over emphasize the pass and remove the decision-making opportunity from the player. This is the simple, short-term solution to the problem. The better solution is to develop the player’s decision-making abilities.

Teach players when to keep the ball and when to pass. Rather than using words, use games to illustrate the key points. As with any learning situation, mistakes will be made, and players should be encouraged to learn from the situation.

Good passes make things appear easy, but bad passes increase pressure and limit the options of the receiver. Good passes result from good technique. To be effective in developing player skill, we need to employ the concept described in the coaching cycle called -build-up. As an example of how this concept is applied to teaching passing technique, consider the following build-up for inside of foot passing.

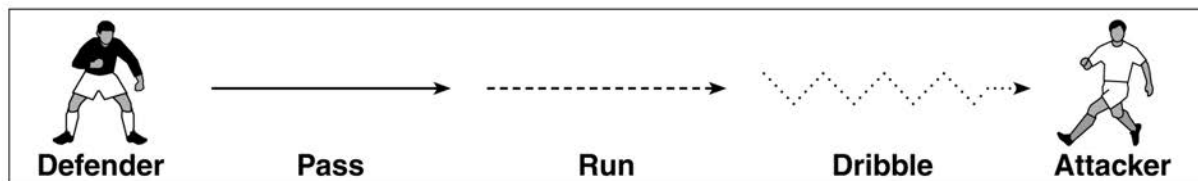

Build-up

Motor movement

During warm-ups, players stand on one foot, swinging free leg back and forth. Alternate feet.

Static drill for technique

Six players pair off to form a triangle, 8-10 yards per side.

A-1 passes to A-2 and sprints to position A-4. A-2 controls ball, sets it up and passes it to A-3, etc.

Coach corrects individual players. As players improve, change one group to two-touch. Then have one group play one-touch.

Figure 12-1

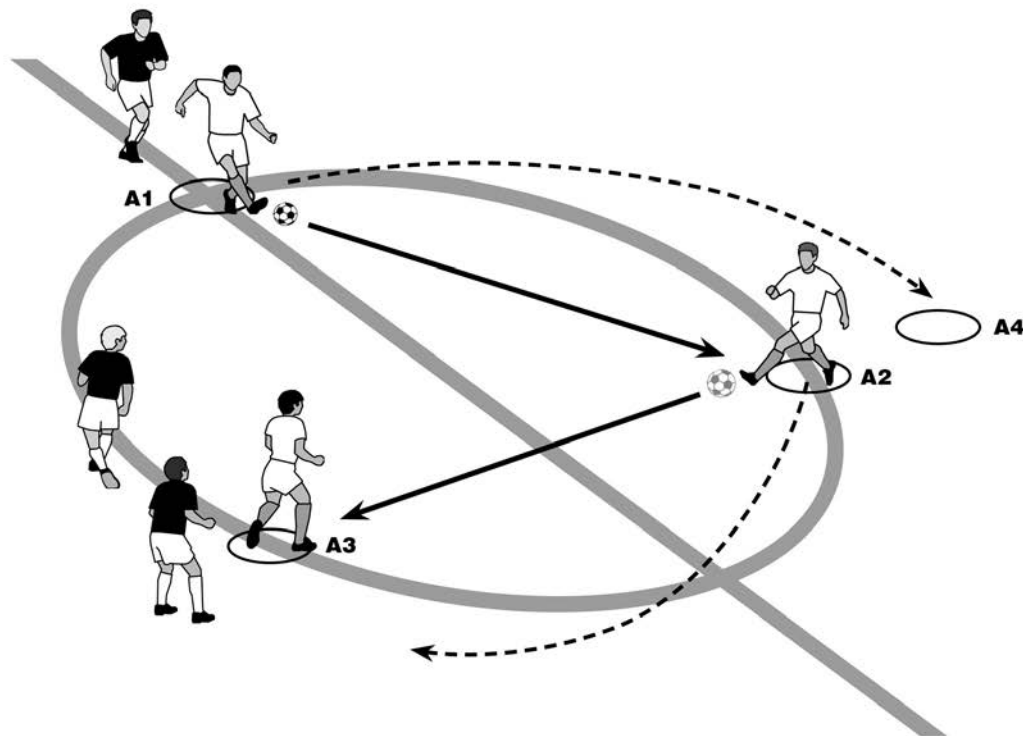

Dynamic drills for technique and pace

- Players pair off, 15-20 yards apart. 1 passes long to 2, sprinting within 5 yards of 2. 2 passes back to 1 who one touches the ball to 2, then back peddles to receive 2's long ball. Repeat up to 10-15 seconds, then rest while passing back and forth. Repeat.
- Players in pairs pass ball back and forth while running across field. First player passes square to partner, then sprints to receive lead or diagonal pass. Change roles after two repetitions.

Figure 12-2

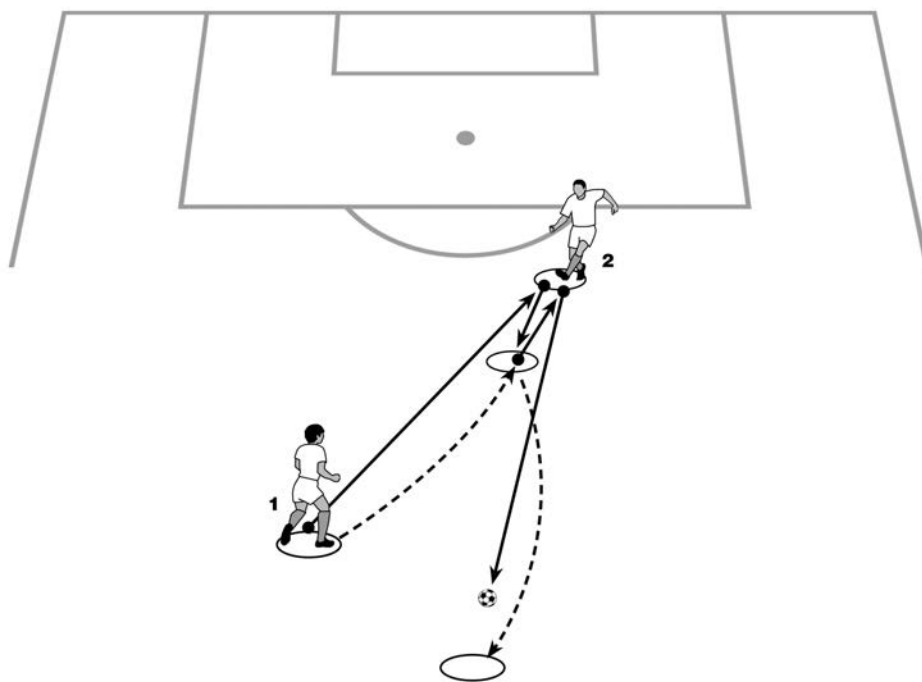

Build-up of speed, timing, and pace - Free play

1. Set up a triangle using cones. A-1 passes (1) to A-2 and sprints toward second cone. A-2's return pass (2) is timed to arrive at A-1's feet at the second cone. The emphasis is on timing. Avoid passing into space past the cone where A-1 must chase or run onto the ball. Reverse direction. Then A-1 and A-2 exchanging positions using a takeover.

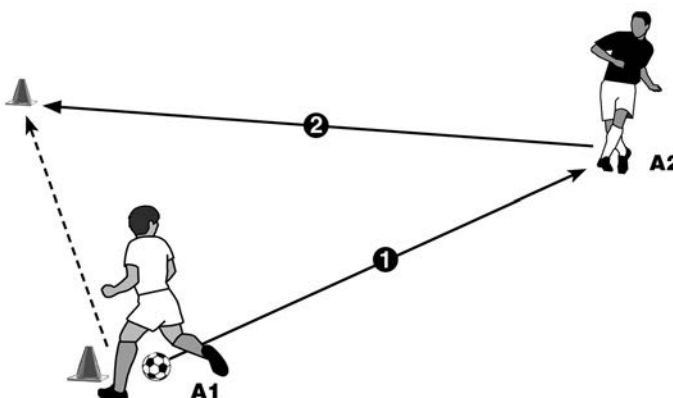
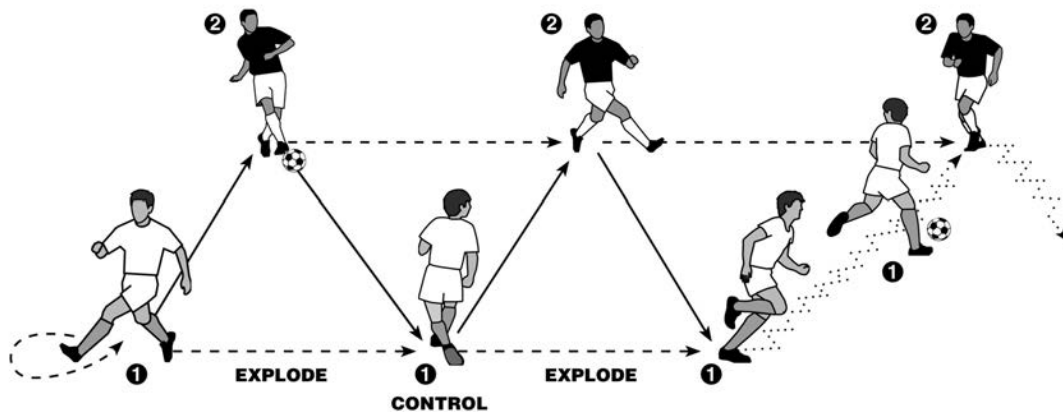

Figure 12-3

2. Free play. Players pair off, 10 yards apart within half or less of the field. On signal, first player passes ball and explodes 5-10 yards. Second player gives lead pass which first player controls, stops, repeats explosion pass, perhaps changing direction to avoid other players. Pair reverses roles by executing a takeover after the second explosive run. Rest after 30 seconds, repeat once.

Figure 12-4



3. Demonstrate control and pass - try to control, but do not stop ball. Repeat (1) above with this variation.
4. Demonstrate passing, sprinting, controlling ball on full run (not one-touch) before making second pass. Execute two cycles.
5. Explain to pairs that they should look for holes between any two players as the second runs. The passer then sprints to receive return pass through this hole. Execute two 30-second cycles.

Build-up of pressure

The introduction of opposition to develop passing technique is best combined with the teaching of tactics. (See "Attacking Methods.")

All of the above steps can be repeated for each type of passing technique to be taught:

- instep drive
- push pass (inside of foot)
- outside of foot pass
- lofted ball

Note: Coaches must develop their own creativity. Design your own exercises and drills.

Finishing

Scoring is the common thread that binds every player who steps on a soccer field. However, not every player has success when the opportunity to shoot presents itself. Shooting is one of the most important soccer skills a player can bring to the game. Many players are unsuccessful when shooting, due to the lack of proper technique and proper mental orientation. If either are missing, goal-scoring effectiveness will be reduced. It is the coach's responsibility to develop proper shooting technique and the proper mental attitude toward shooting.

All of the various kicking techniques may be used for shooting, but the most often used technique is the instep drive. For a shot on goal, the ball is struck on the top of the foot at the shoelaces. The ankle is locked as far down as possible, as are the toes. The non-kicking foot is planted beside the ball, pointing at the target, with the leg flexed at the knee and hip. The kicking leg is cocked at the knee. The actual kicking action starts with a forward movement of the thigh and completed with a final rapid motion of the lower leg and foot through the ball. The foot must be kept in alignment with the knee to produce a straight shot. Hit the ball at its mid-point to keep it low, or below the mid-line to produce loft.

Throughout all of the kicking motion, the head remains steady with eyes focused on the ball. In developing a build-up for shooting, we need to keep in mind how the technique will occur in a game situation. Consider the following build-up to develop team shooting skills.

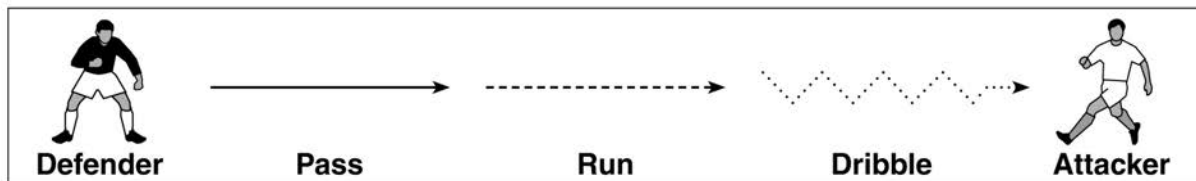

Build-Up

Motor Movement

As part of the warm-up, players practice movement. Alternate feet.

Static/Dynamic Organization

1. Players practice shooting with stationary ball between cones placed in a row 8 yards apart. (Two balls, two pairs per goal)
2. Same as (1) above, but player taps ball while moving toward goal.

Figure 13-1

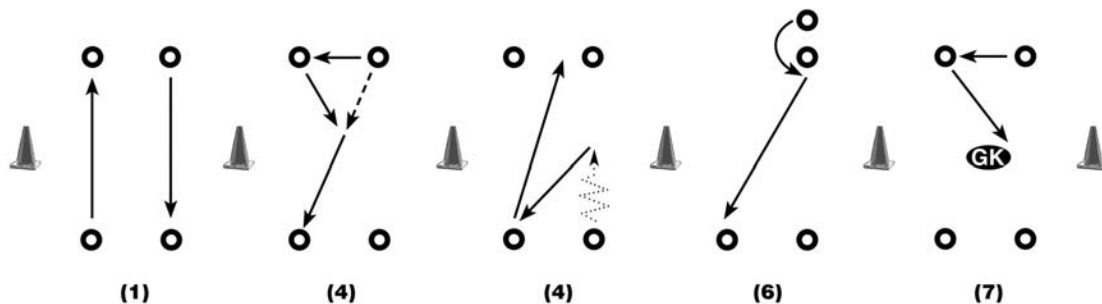

3. Same as (1) above with ball moving left or right.
4. With one ball, partners take turns serving and rolling balls away and toward shooter.
5. Partners set up shots by making wall pass.
6. Partners take turns serving bouncing balls that move toward goal.
7. Same as (6) above, except balls are served from any direction. Use goalkeeper to build up opposition.
8. Note: The above organization maximizes the number of players shooting, avoids players waiting in line, has players chase own balls, permits assistant coaches to become involved in coaching process, and utilizes a minimum of space. In addition, players should be discouraged from shooting at the center of an empty goal.

Pressure Drill (Fun Game)

1. Set up a 40-yard field with mid-line and two cone goals, four players per team, retrievers, and a coach with several balls. Players must remain in their half of the field.
2. The coach serves the ball to O-2 who passes to O-3, who shoots the first time. If team D can control the ball, they set up the first time shot for forwards. All goals and balls out of bounds are collected by retrievers, who return balls to coach.
3. Coach keeps things moving fast by throwing in a new ball immediately when required.
4. Defenders cannot use hands, but must control ball.
5. Coach should encourage long, hard shots by passing forward, backward, and square. Ensure success by opening goals. If necessary, shorten field. Keep shooters alert by putting a new ball into play quickly.
6. Rotate retrievers in and out, one per side approximately every two minutes.

- 7. Variation: Add D-5 who can play on O's side of field to pressure O shooters. If able to steal ball, D-5 has option to attempt to dribble through goal or pass back to teammates. Simultaneously, add O-5 who plays on D side of field.

D. 1 vs. 1 Utilize 1 vs. 1 drills with and without goalkeeper.

As soon as the basic shooting technique is mastered with rolling balls, give the players opportunities to practice against the opposition. A small-sided game, like the one below, can help produce attacking chances and teach shooting.

Figure 13-2

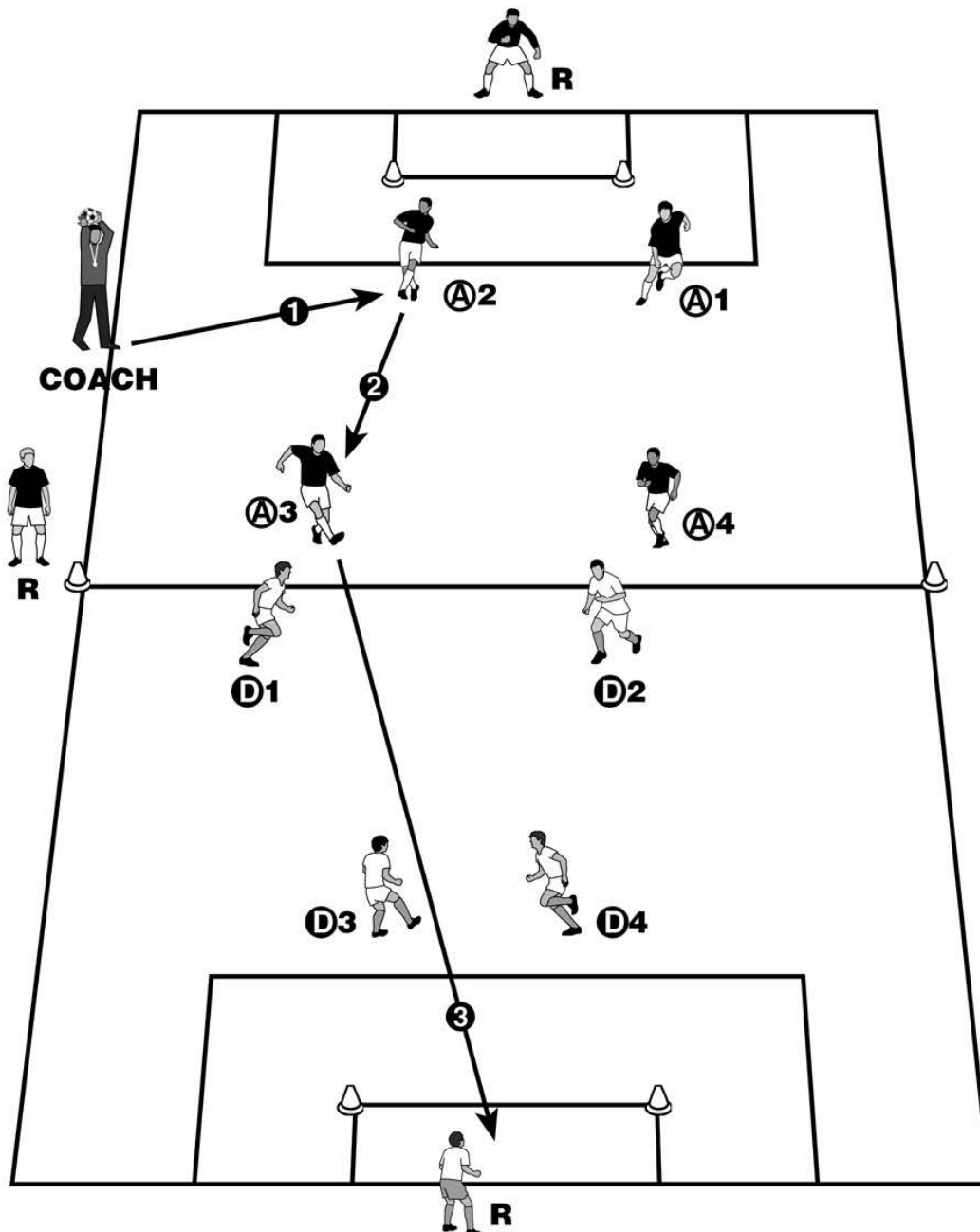

Small-sided game: 2 vs. 1

Set up two goals or pairs of cones approximately 30-40 yards apart. Team 1 employs two attackers and goalkeeper, attacking team 2 with a single defender and goalkeeper. A third player for team 2 rests behind his own goal. Team 1 shoots or loses the ball. The player shooting or losing the ball becomes the defender, assisting 1 player sprinting to the rear of his own goal. The team 2 defender and keeper immediately attack, and the resting player becomes the goalkeeper. Coach works on rotation for first few attacks, then permits players to play on their own. Stop once in a while to remind the players of previous lessons. Run two games at once to exercise team.

Figure 13-3

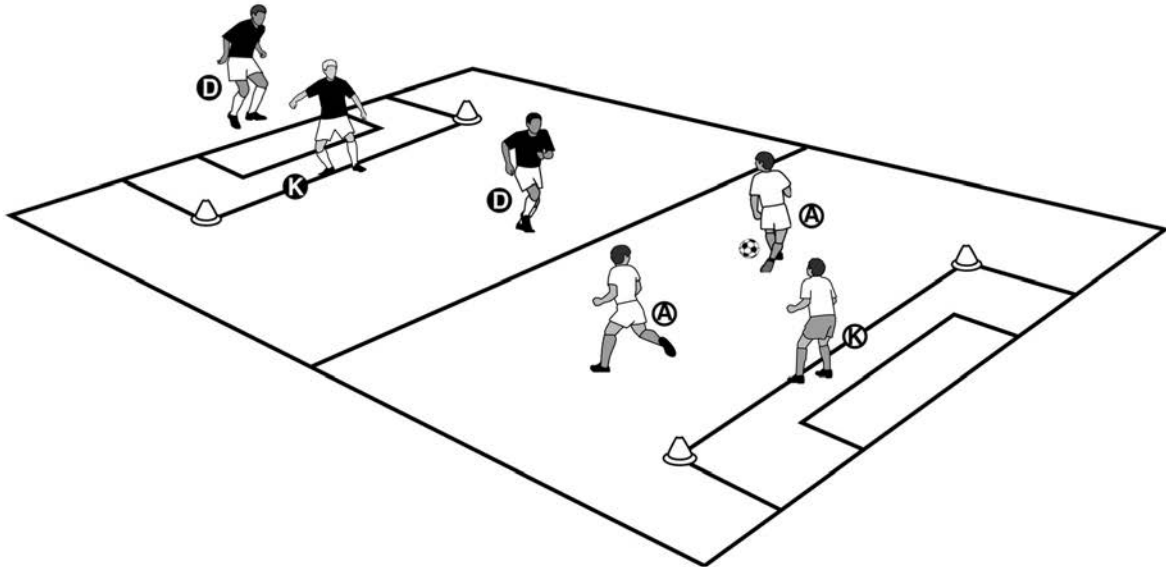

There are several key points that players should keep in mind during shooting practice.

- Locate goalkeeper before shooting.
- Select location for shot (corners are best, low is best).
- Relax when shooting.
- Keep head steady and employ proper technique.
- Concentrate on accuracy over power.
- Better to miss wide than shoot over the bar.

Coaches must often work to develop proper attitudes in their players towards shooting. It is common in young players to pass up good shooting opportunities in order to get a better shot. Very often these better shots do not materialize and a scoring opportunity is missed. Players should be encouraged in the following:

- Determine and understand their effective shooting range.
- Shoot when the opportunity is present (before defender is close).
- Take shots from good shooting angle.

Figure 13-4

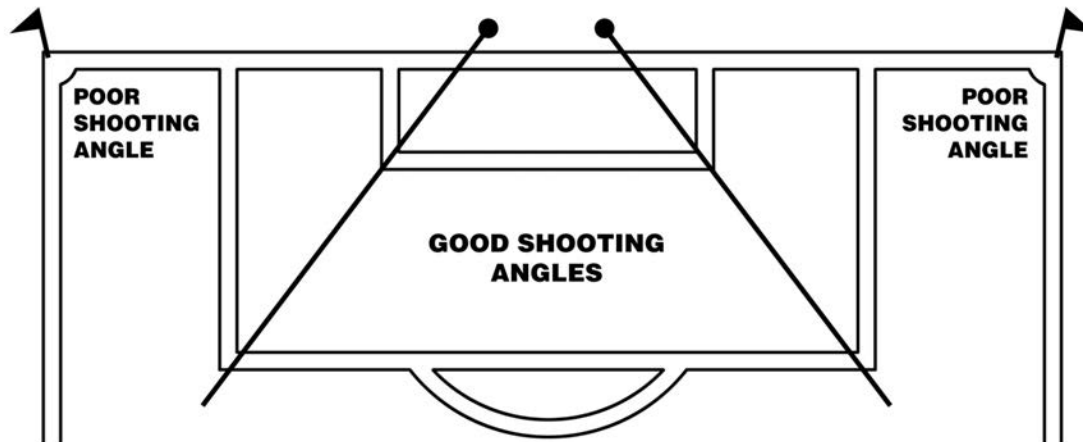

Most goals are scored from positions directly in front of the goal. Many times shots are taken from positions with low shooting angles. The odds are very low against scoring from these positions. The goalkeeper should be positioned to protect the near post. A better tactic is to have A-1 pull the ball back to A-2 positioned near the back post. There are several advantages to this.

1. A player behind the ball is not off-side.
2. Space is created behind the GK for A-2 to shoot.
3. Defenders must turn to face their goal in order to clear the ball.

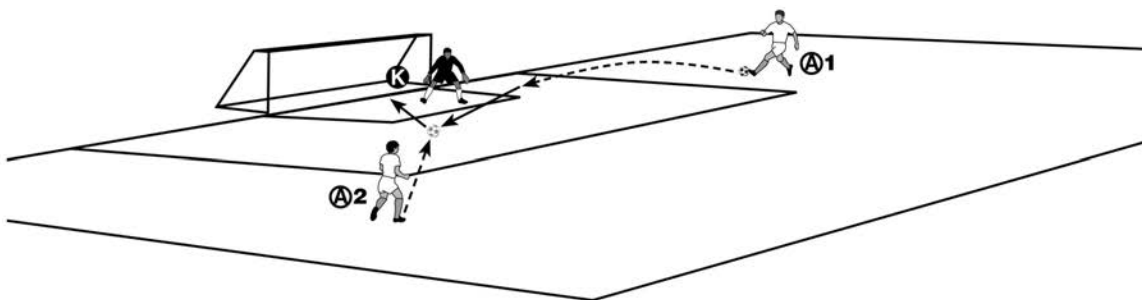

Figure 13-5

Heading

Heading represents a player's earliest opportunity to play an air ball. It also causes more apprehension than any other soccer skill, particularly with younger players. Therefore, the coach needs to be concerned with dealing with the apprehension and the poor technique which may result. Very little heading is displayed in games prior to Division 4 (under 12). Teaching correct heading techniques from the beginning will allow exposure at younger ages without fear and will encourage use as the players get older.

Heading can be used in attacking to shoot or pass, or it can be used to win a 50-50 ball. Accuracy is essential and should be emphasized. Defensively, it can be used to clear a ball from a dangerous situation. Emphasis here should be placed on power and distance to move the ball clear of the danger zone.

The basic techniques for heading the ball are as follows:

- Contact the ball flat on the forehead, above the eyes.
- Keep eyes open.
- Keep mouth closed.
- Neck should be kept rigid.
- Propel trunk forward from waist to meet ball.
- Arms should be used for balance and protection.
- Follow through after contact.

These basic techniques apply whether heading face on, turning to change direction or jumping up to head in the air. When turning to change direction, however, contact with the ball is made more to one side of the forehead.

Consider using the following skill build-up drills to teach heading:

1. Have the players practice the basic movement without the ball. Then, have them bring the ball to the forehead, increasing speed and force.
2. Players lob balls into the air and as they come down, make contact with the forehead, increasing speed and force.
3. Have one player in a sit-up position with hands tucked behind bent knees. As the player thrusts his upper body forward contact should be made with a stationary ball held by a partner. Build this up by having the partner throw the ball underhanded, adding distance and speed.
4. Continue the build-up by moving to a kneeling position and then to standing. Again, add distance and speed.
5. Add turning of the head for direction change to any of the above. Once the players have mastered the basic techniques, you can have them head the ball back and forth between partners while standing still. Add movement. The distance between players can be adjusted depending on the players' proficiency.



You can also add movement by having the server toss the ball to the side, behind or in front of the header who must move into position to head the ball back to the server. Once this skill is mastered, add another server: increase the pace and distance of the throws.

As a final build-up to heading, you might want to add defensive pressure. Return to using one server and begin with passive pressure by having a defender stand in front of the player heading the ball but making no attempt to play the ball. Once the player feels comfortable with the defender's presence, have the defender apply light pressure by jumping and trying to head the ball. It is important that the defender not be overly aggressive.

A fun game to play that builds the heading skills you have now taught your players is Throw-Head-Catch. Divide your group into two teams and use a small field with mini-goals. The object of the game is to score in the other team's goal by heading the ball. The ball is in play as long as it follows a throw-head-catch sequence. Players may catch the ball with their hands only if the ball has been headed by another player, either attacking or defending. The player can then run with the ball (limit the number of steps to three or four) before throwing it to a teammate to head. A player receiving a thrown ball may only head the ball in order to play it to a teammate or to shoot on goal. Players may not consecutively throw and head the ball. Either team may attempt to catch or head the ball and if the ball touches the ground, the opposing team takes possession and starts play again.

When heading to shoot on goal, the ball should be struck on its upper half to direct the ball downward. This will result in a shot that is more difficult for the goalkeeper to save.

To head the ball defensively, the lower half of the ball should be struck for maximum height and distance. This gives other defending players time to reorganize and reduces the immediate threat of a shot on goal. The ball should not be headed to the ground where the opposition can begin another attack.

Defending Methods

Build up defending tactics by applying principles of play and exercises from “Coaching Cycle.” Place emphasis on stopping scoring, positioning, delaying attackers until support is near. Regain possession with appropriately timed tackle, and executing counter attack with good distribution to a teammate.

Start with 1 vs. 1

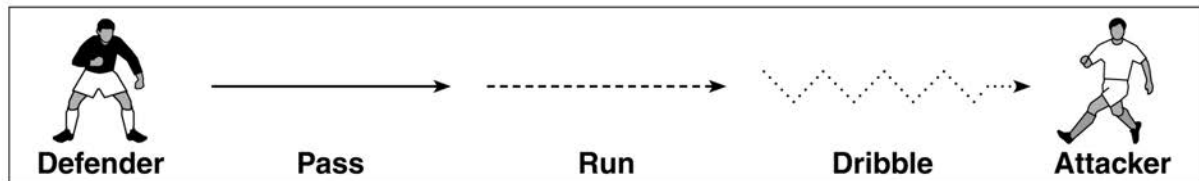

Tactical Objective

To pressure an opponent, force him to look at the ball, deny the through pass, and avoid being beaten by dribbling tactics. Impress upon players that they do not have to win ball, and that a backward or square pass by the attacking team is an acceptable result for the defense.

Pressuring Demonstration

1. **Demonstration of poor pressure:** Have players rapidly advance directly toward the dribbler in an effort to win the ball. Because of the pace and closeness of the challenge, the dribbler can, with a sideways or drawback movement, move the ball out of the reach of the running defender.
2. **Demonstration of good pressure:** This time the defender approaches rapidly, but stops about two yards in front of the dribbler. From this position, the dribbler cannot use the defender’s momentum to his or her own advantage. The defender is now set to react to any movement of the ball, while remaining close enough to apply pressure to the dribbler and prevent a through pass.
3. **Demonstration of varying pressure:** Show that the defender must not get too close because the attacker can accelerate straight ahead and the defender must turn. Emphasize, however, that the closer the defender comes, the more pressure can be applied and the smaller the chance for a penetrating pass by the attacker.

Delay

Motor Movement

Organize players into pairs with one player designated as attacker and the other as defender. The defender takes a proper defensive stance, which is 1-2 yards in front of the attacker, but not so close that the attacker can fake and sprint past defender. The defender should be close enough to get the attacker’s head down, and is facing the attacker with one foot in front of the other in a “boxer’s stance.” On signal, the attacker begins to advance (without a ball) and the defender tries to maintain proper positioning and distance from the attacker. Let this continue for 10-15 yards, then reverse

roles. Now let the attacker move in a slight zigzag motion and encourage the defender to maintain proper positioning. Caution the defender not to cross feet or to lose the boxer's stance. As the attacking player changes direction the defender should always face the attacker. Now introduce a ball into the exercise. The defender may not tackle but should strive to maintain good defensive position. Only after the coach is satisfied with the defensive positioning and has taught proper tackling technique should the defense be allowed to tackle.

Drill for technique

- Set up four 10 x 15 grids with a defender in each grid. Attackers are divided between the grids. Defenders try to delay the advance of attacker in each grid. Defenders remain in the grid until told to change. Start with no tackle condition.
- Defending stance.
- Get positioned – front to back, knees slightly bent.
- Weight on back leg.
- Arms out for balance, body leaning slightly forward.
- Eyes focused on ball.
- Don't cross legs.

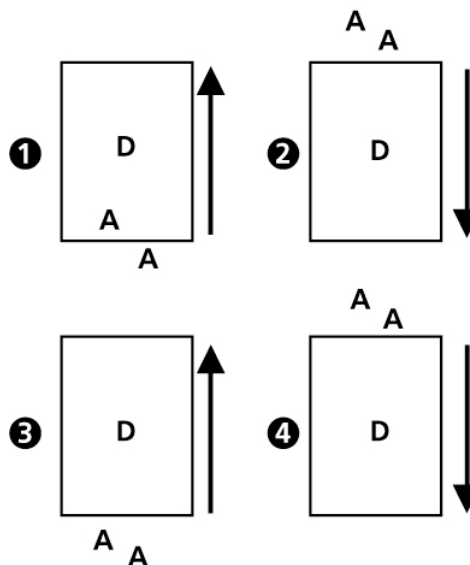

Figure 15-1

Drill for transition training

Two lines of players 10 yards apart. Line A player dribbles toward line B. Approximately 3 yards from line B, dribbler executes a pass, player B collects ball, “explodes” towards line A. Original dribbler must quickly turn to make recovery run attempting to stay slightly in front of and to side of new dribbler.

Note: As drill is executed, each player ends up at the rear of the line originally started in.

Figure 15-2

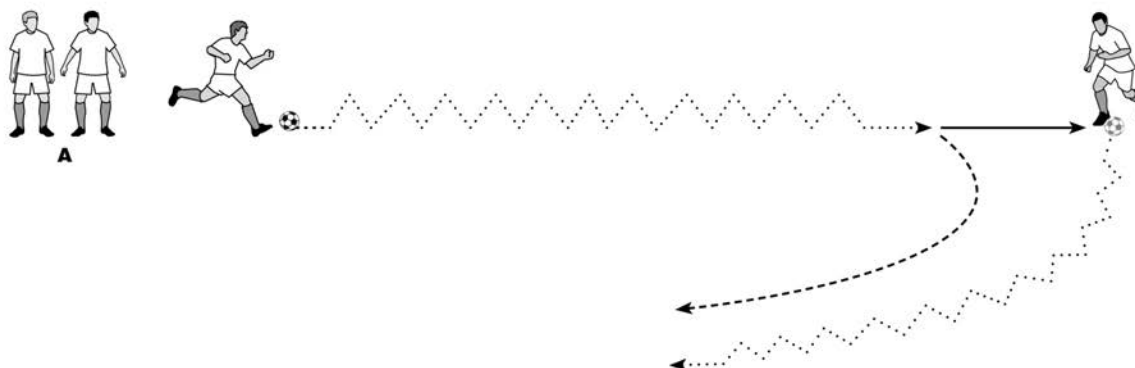

Controlling the Attacker (Shepherding)

The training must now focus on the position of the ball relative to the goal. Consider the situation shown below where the attacker is located near the touch-line. The defender should play between the attacker and goal and should overplay the attacker to force the play down the touch-line to less dangerous areas. Overplay by applying pressure to the attackers inside shoulder. To train for this situation set up the following exercise.

Figure 15-3

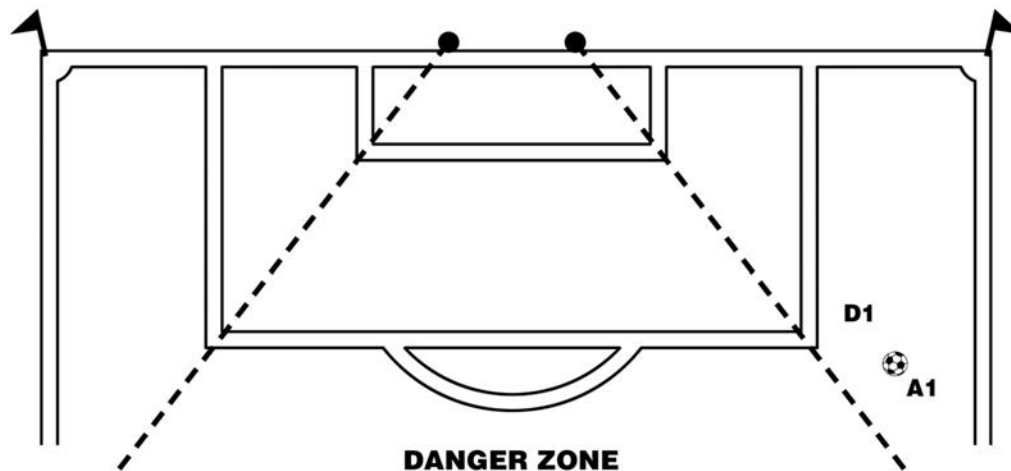

Attacker A-1 dribbles ball past cones and is challenged by defender D-1. The approach run by D-1 is on the inside shoulder of A-1 to force down the touch-line. D-1 should sprint toward A-1, slow down and begin to match speed of attacker. Employ good delaying tactics by applying pressure to get the attackers head down.

Figure 15-4

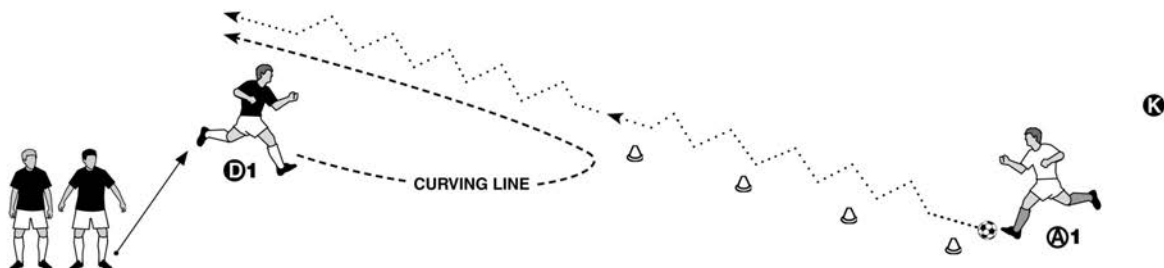

Move exercise toward center of the field. The defender should try to force the attacker to play in a predictable direction

Figure 15-5

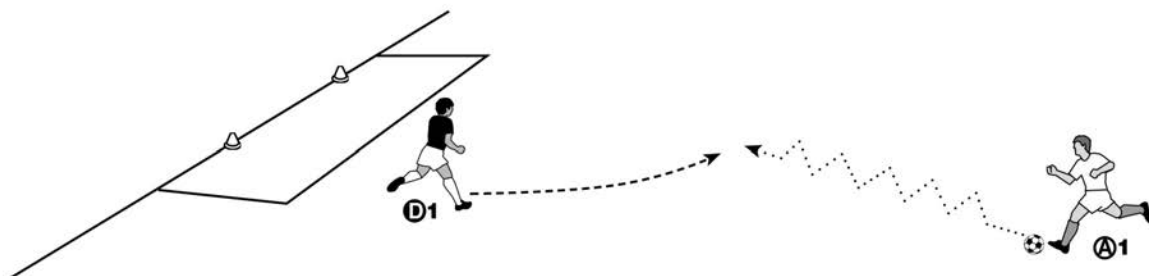

The defender should force the attacker onto the weak foot or toward defender's supporting teammates, never running directly at the attacker!

Front Block Tackle

Technique

The front block tackle is an individual defensive technique which should be taught to players to improve their defensive play and to reduce the potential for injury. The player should be in a balanced position with feet spread, knees slightly bent and the body leaning forward from the waist with weight on the non-blocking foot. The blocking foot has the ankle locked up and the foot turned out. The center of the ball is struck with the middle of the foot in a short power motion. The body weight is kept low throughout the blocking action. Typical problems that develop are lack of balance, weight distribution, timing and judgment. All of these may be overcome with practice and experience.

The block tackle may be taught during warm-up by allowing the players to practice the blocking motion without a ball. After assuring that each player can perform the correct body motion, introduce a ball into groups of two. The ball is positioned between two players who step up, on signal, to contact the ball together. As the players' technique improves, open the distance between them and repeat. Now allow the defender to try to win the ball in the tackle. Incorporate a partner for the defender to distribute the ball to after a successful tackle. (See example.)

Figure 15-6

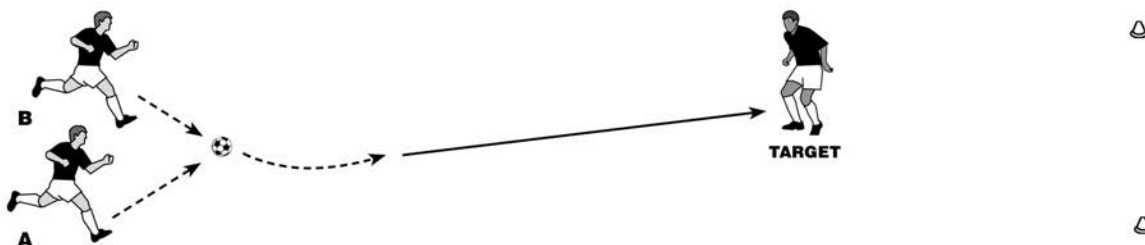

Players A and B try to win ball on signal, with winner playing to Target Player (T) for a 2 vs. 1 build-up to goal. Player losing tackle must act as single defender.

2 vs. 1 Situations

There are situations where a single defender is confronted by two attackers. The defender must delay the advancement of the two attackers so that other defenders have time to recover.

Figure 15-7

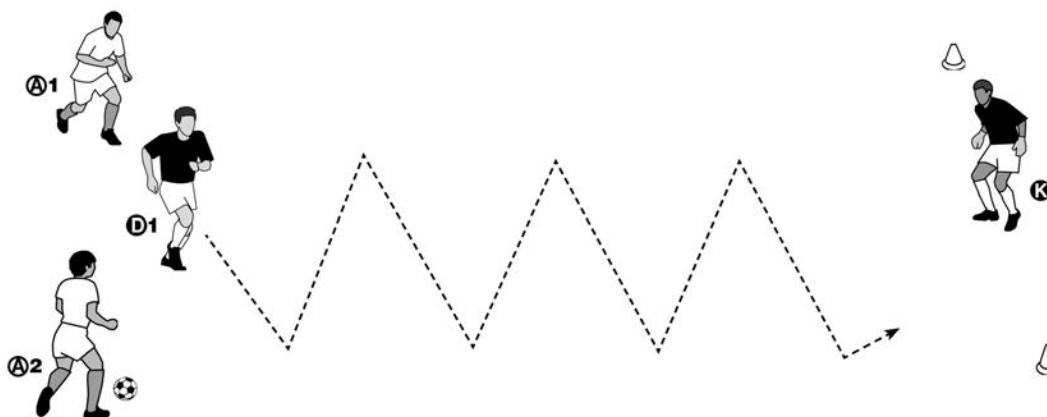

The defender D-1 must keep both players in view at the same time. Pressure is applied to A-2 and when the pass is made to A-1, the defender must adjust in a zigzag fashion as shown above. The

defender gives ground grudgingly, but a time comes when the defender must stop retreating. This occurs as the defender reaches the shooting range of the attackers. At this point, the defender must rely on the goalkeeper to provide support. For many situations, this occurs near the top of the penalty area. Variation: perform above exercise with a recovering defender to bring numbers to 2 vs. 2.

1 vs. 2 (Support or Depth)

Structured Drill

D-1 passes ball to A-1 who turns and attacks D-2. The latter attempts to delay A1, keeping the player from crossing the goal-line. D-1 rushes to support. When in direct support of D-2 (i.e., 3-4 yards behind), player directs D-2 to attempt tackle upon instruction from D-1.

If D-2 is beaten by A-1, then D-1 must delay A-1 until D-2 has taken up a supporting position. Running from behind the ball to a defensive position ahead of the ball is called recovery. When a defender is beaten or must recover from near the touch line, the recovering player must run toward the near post to reach the new support position. If the recovering player is near the center of the field, the recovery run is toward the penalty-kick mark. Recover immediately when beaten.

Figure 15-8

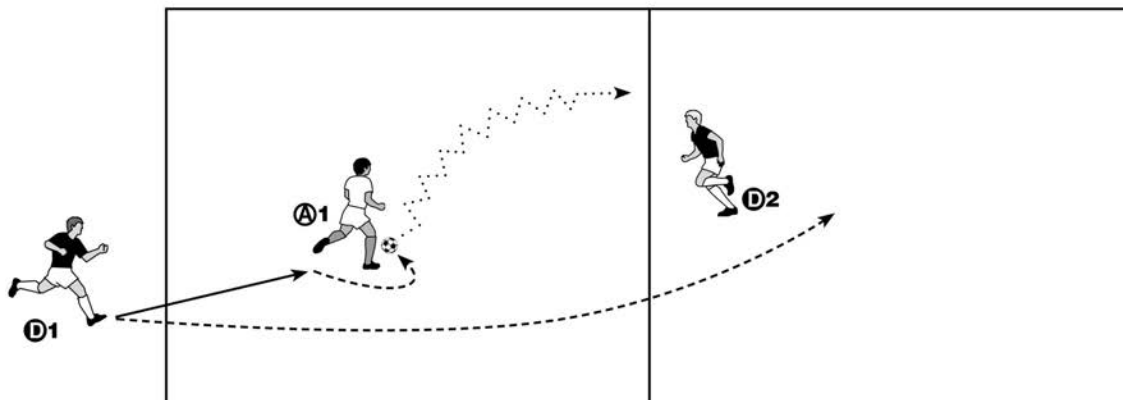

2 vs. 2

2 vs. 2 require the player marking the player in possession to play close to pressure the dribbler. The defender's teammate must "drop off" the opponent and help cover the teammate as shown in Figure 15-9.

When the ball is passed to A-2, D-2 must apply pressure and D-1 must move to give cover in case A-2 beats D-2 as shown in Figure 15-9. This 2 vs. 2 can be used as a structured drill to help teach the concept of cover. The covering player must take care not to become a "ball watcher" and completely forget his opponent.

The supporting defender should take up a position to cover the pressuring defender if beaten by the attacker. This position would be 3-4 yards behind the pressuring defender. Without defensive support, the pressuring defender should delay, contain, and not tackle. With defensive support, delay and contain first then wait for communication from supporting player before deciding to tackle.

Figure 15-9

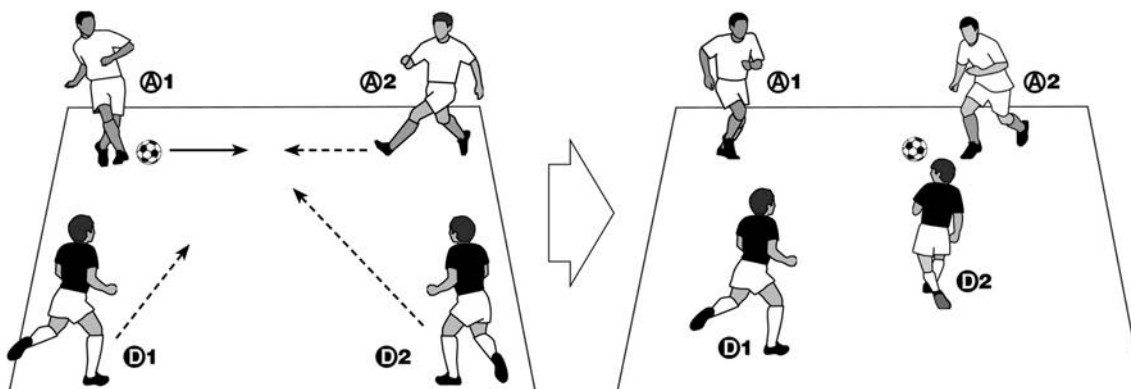

The 2 vs. 2 situation requires the 1 vs. 1 defensive skills and the supporting position skill to be used in the same drill. The position of the players is shown Figure 15-10.

Figure 15-10

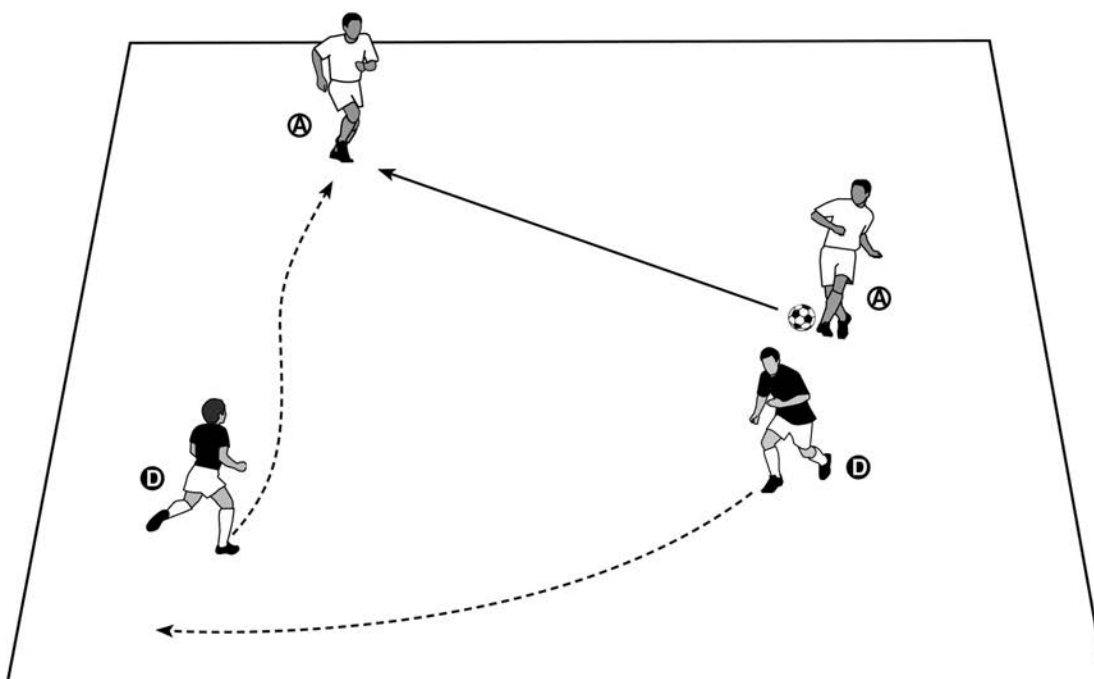

The recovered player must take position behind the defensive player playing 1 vs. 1. The player must be able to help if a teammate is beaten and be able to pressure the ball if a pass is made to the other attacking player. When the ball is passed, the defensive players switch roles. This situation does not allow tackling of the ball because the defense does not have a player advantage. Therefore, the 2 vs. 2 is a delaying tactic and does not necessarily win the ball unless the offense makes a mistake. Both players try to make the attackers pass the ball either square or back.

The defense can be beaten if the defensive players become square across the field, which usually happens when the defensive players switch roles, as shown.

Figure 15-11

In Figure 15-11, the defense is beaten by a through ball placed between the defending players. A running attacking player can then collect the ball behind the defense. To prevent the through ball, the switch must occur the instant the pass is made.

If the support person pressures the player receiving the ball soon enough, and at the same time gets into the most likely direction for the pass, the through ball cannot be played.

The above concepts may be taught in a 2 vs. 2 game shown in Figure 15-12. The two attacking players should be constrained by the off-side rule and their objective is to dribble the ball, under control, over the goal-line. Play is continuous.

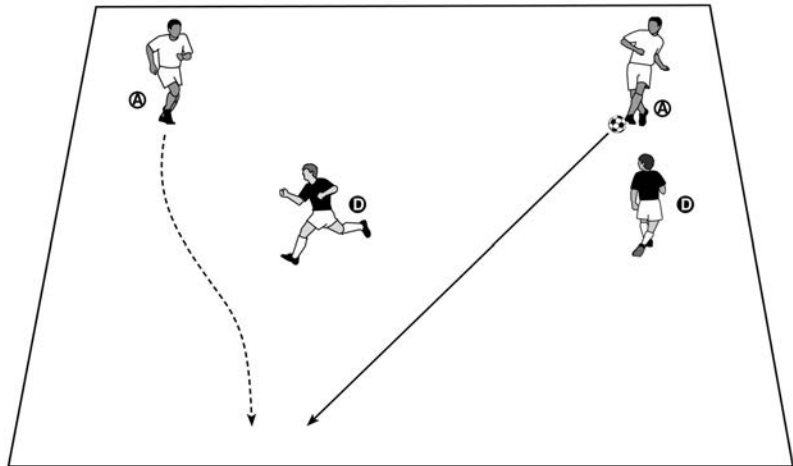
Figure 15-12

- 15 x 15 grid
- 4 players
- 1 ball

Variation: Place a target player at the ends of the grid. Attacking players attempt to deliver ball to targets. Encourage defenders to pressure attackers to prevent delivery.

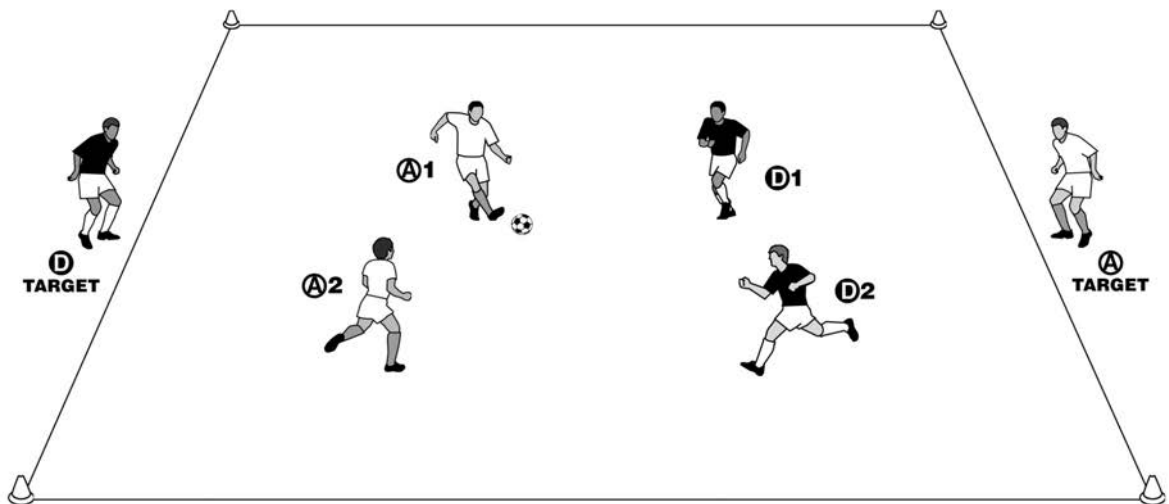
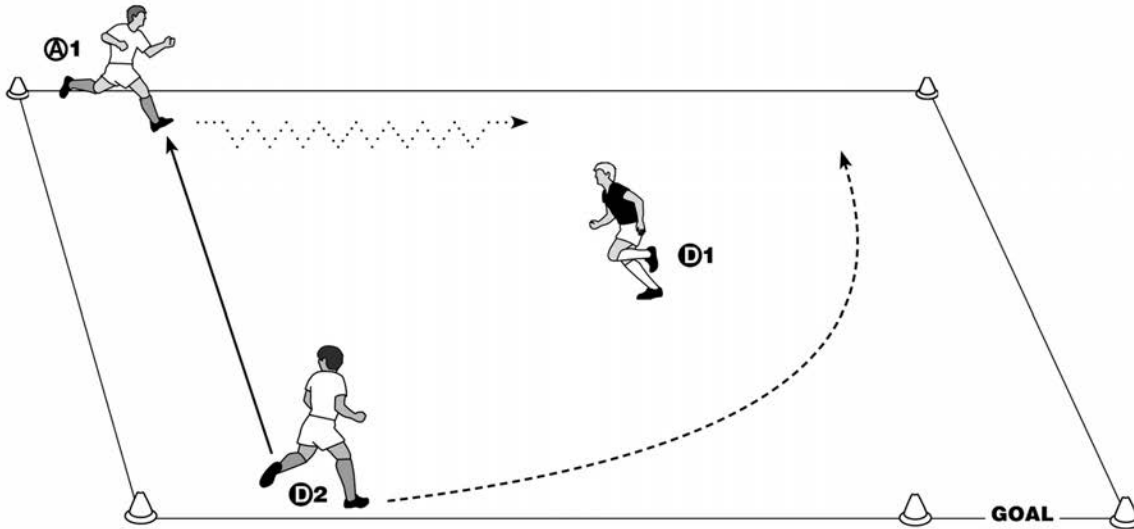

Figure 15-13

- 1 vs. 2, recovering defender
- 4 players-1 ball
- 15 x 20 grid

Player D-2 passes to A-1 who begins to attack D-1. A-1 tries to dribble and “cross” the ball through the goal. D-1 runs to a supporting position and assists D-2 in defending.



3 vs. 3

When another attacking player and defending player are added, a midfield situation of 3 vs. 3 is created. This is a delaying and containing situation. The defense does not have an advantage, and tackles should be made only if the ball can be won.

Figure 15-14

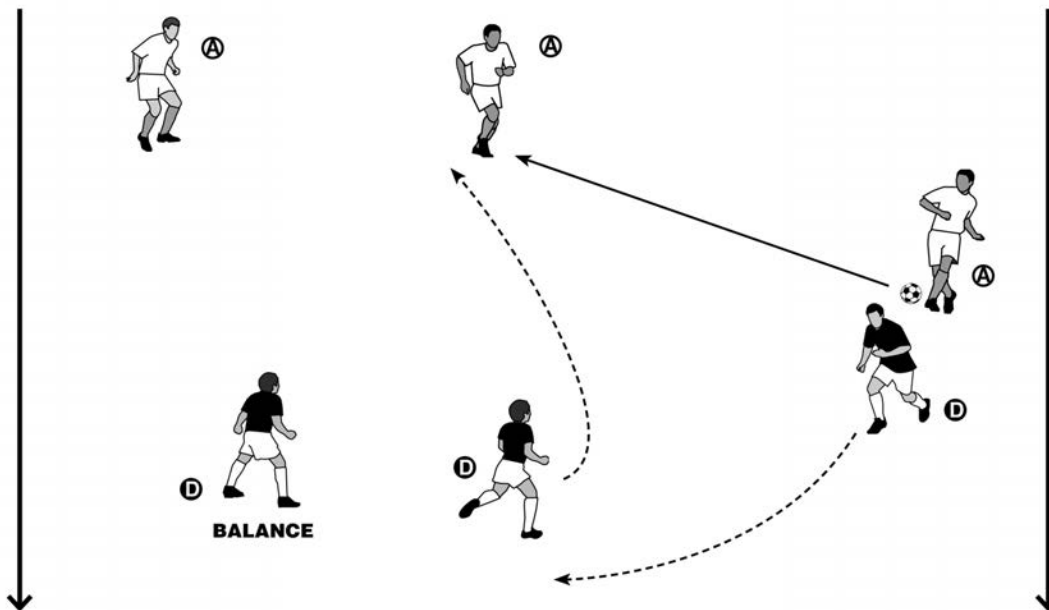

Communication is now of utmost importance. One person must immediately pressure the attacking player with the ball. When the ball is passed, another defending player must announce he is on the ball and begins to pressure the attacker in possession. One player must always be in close support of the player applying pressure to the ball. The other player must provide balance for the defense and should support in a position to pressure the ball, should it be passed to the third attacking player.

Figure 15-15

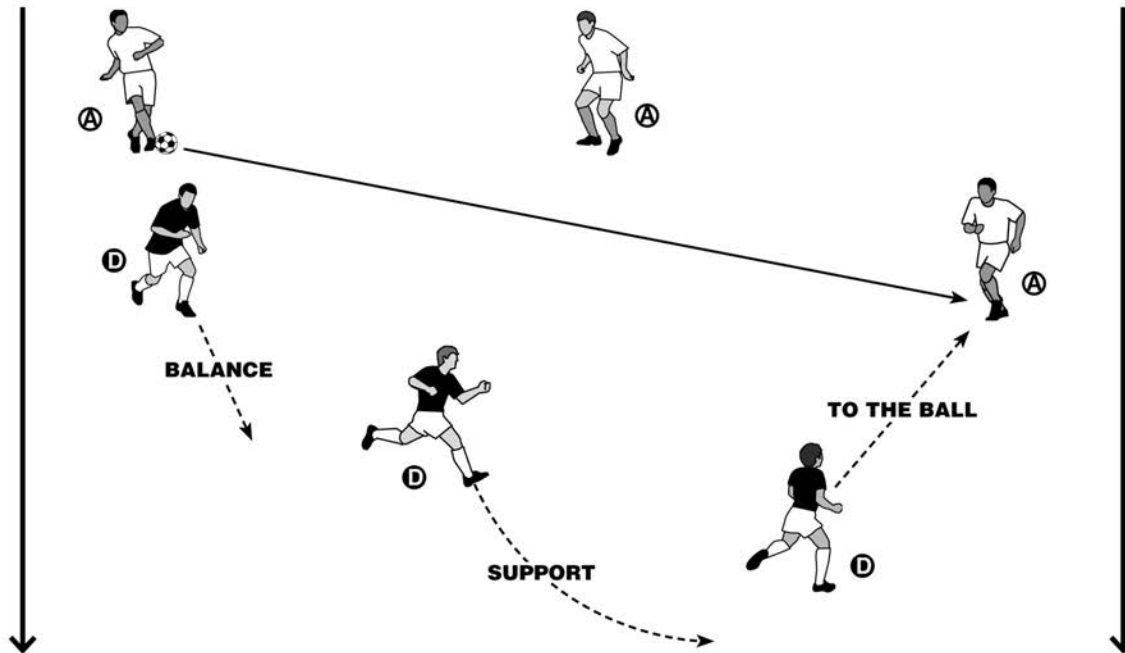

All the defending tactics of the previous drills are necessary for successful midfield defensive play: 1 vs.1 containing; 2 vs. 2 delaying with support; and 2 vs. 2 switching and denying the through ball. All that is now needed for the defense to try to win the ball is an additional defensive player moving into a position ahead of the ball or a mistake by the opponents.

The most difficult task of a coach is to get players to recognize their constantly changing roles during the game. They must try not to make mental mistakes. The players must continually ask who is on the ball, who is in support of the player on the ball, and is the defense balanced so that pressure can be applied if a long pass is delivered? Recovering runs must be made if the defense does not have an advantage in the area of the field near the ball.

Three defensive players must begin to establish a balanced defense. This generally takes the form of a triangle with the defending player pressuring the ball being supported by at least one teammate. Consider the following situations.

Figure 15-16

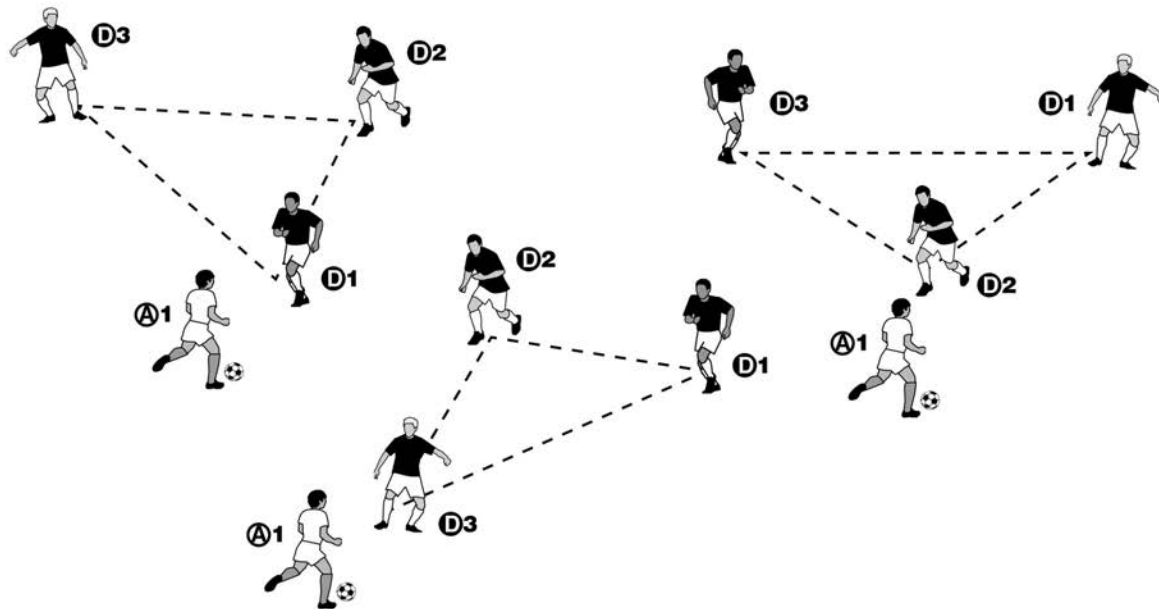

To train for defensive balance, play 3 vs. 3 as shown in Figure 15-17.

Figure 15-17

- 6 players 1 ball
- 30 x 30 yard area

The attacking objective is to dribble ball under control over the goal-line. There is no offside, and play is continuous. Encourage defensive communications and establish defensive support and balance. Apply pressure to the ball to prevent advancement. Force the play square or back. As a variation, place the target players on the four corners of the grid. The attacking goal now is to get ball to either target player. This situation approaches the conditions present in the game.

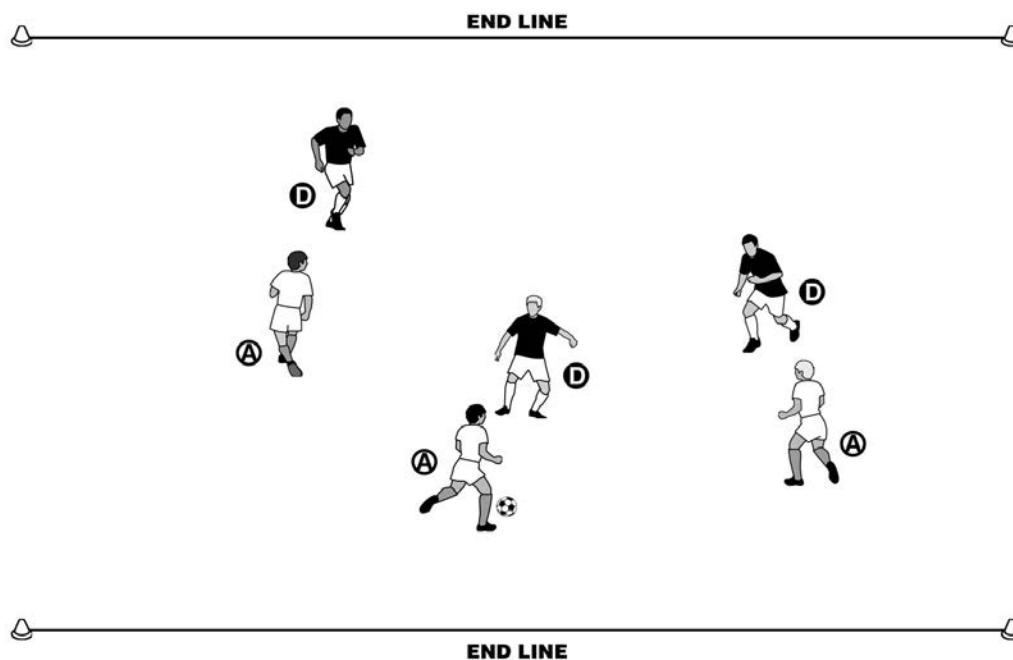



Marking

Regardless of the type of defense a team uses (zone, man-to-man), effective marking must be employed. Often the best defense is to deny possession to attacking players. By staying close to an opponent, the defender

1. discourages passes to the opponent,
2. forces the opponent to move away from the goal to receive a pass,
3. is in position to intercept the pass or make a tackle as the opponent is trying to control the ball, or
4. unsettles the opponent.

The position of the marking defender is influenced by a number of factors which include positions of the ball and the goal relative to the marked attacker. The forward should be more tightly marked as

1. the player moves into a more dangerous shooting position in front of the goal.
2. the player off the ball moves to a position to quickly receive a pass.

The general objectives for marking a player not in possession of the ball are to

1. be aware of the attacking space behind. Be alert for through passes.
2. intercept the pass, if possible.
3. if the pass cannot be intercepted, pressure player receiving pass before ball is under control.
4. if unable to prevent player from controlling pass, do not allow attacker to turn and face goal.
5. if opponent has turned, begin to delay and control opponent until support arrives and instructs defender to tackle ball.

To accomplish the objectives, the marking defender should take up a position on the goal side and ball side of the attacker. The defender must see the ball and the opponent without turning the head. The distance between attacker and defender must vary with distance from the ball which allows the defender to intercept a pass intended for the marked attacker. This means tight marking near the ball and loose marking across the field. If the pass is received and the attacker's back is toward the defender, the defender should take up the boxer's stance. The defender should not crowd the attacker but should take up a position (1 yard away) to see the ball. Be prepared to tackle as the attacker begins to turn. Watch the ball, not the opponent. If opponent successfully turns, then utilize previously introduced techniques of delay and control.

Marking Drills

1. Six players are placed in a 20 yards x 20 yards area and divided into two teams with partners marking each other. The coach stands at the edge of the area holding a ball and designates one team to start. Members of that team must move away from the coach and try to elude their markers. The players explode into open space with the coach throwing the ball for them to catch. The player who throws the ball back to the coach scores one team point. Possession is lost if player is touched by the marker while holding the ball.
2. Play a game of "keep away" in half of the field. Again, players are paired and marking each other. Only a partner can take the ball away. Teams try to pass the ball among themselves. The coach decides the number of consecutive passes required to score a point.
3. Play the same as (2) above but give each player on each team a number. 1 must pass to 2, 2 to 3, etc., until the last person passes to 1. If there is a loose ball, the player who regains control starts the rotation by passing to the next player. Points are usually scored by passing the ball through the whole team.

Classic 3-fullback pivoting defense

This type of defense involves all three of the back defenders and represents a simple way to implement the defensive principles of play. The center fullback (D-2) is the pivot point for our defense with the outside fullbacks acting as rigid arms attached to the pivot.

Consider the situation below:

Figure 15-18

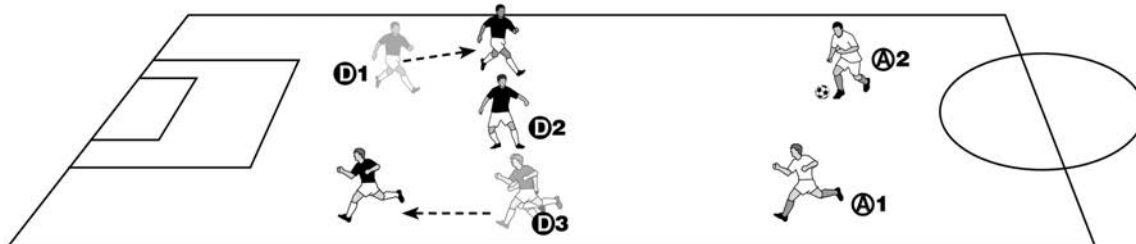

Attacker A is challenging the back three defenders. The defense pivots about D-2 with D-1 moving to new position D-1 to challenge the ball. Defender D-2 provides support and D-3 provides balance. If the ball is crossed to attacker A-1 then the defense would again pivot about D-2 as shown in Figure 15-19.

Figure 15-19

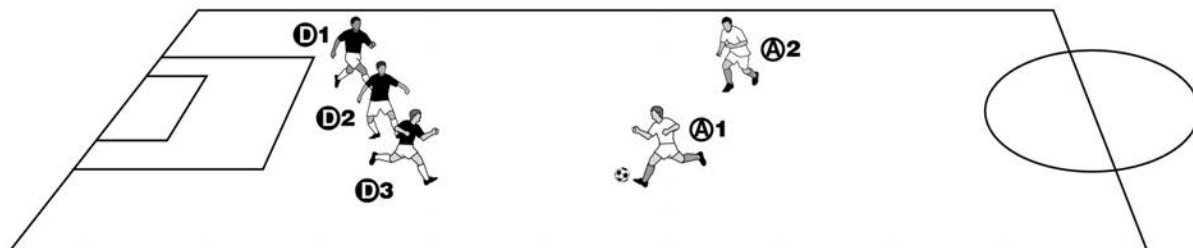

This type of organized defense is easy to teach and generally effective. This defense does violate one of the principles of play - depth - when the defense pivots as the ball moves as illustrated above. As D-1 moves forward, and D-3 moves back, there is a point when the defenders are vulnerable . . . playing in a straight line across the field. The defense is susceptible to a through ball at this point. This rotation must occur very quickly to avoid problems with depth.

Counter attack training

1. Coach or server feeds ball toward goal. Player tracks down and dribbles ball to touch-line in wide U-turn, never across front of goal.
2. Repeat (A) above, but with goalkeeper (the "king"), who gives directions verbally and by pointing toward the side that turn should be made.

Figure 15-20

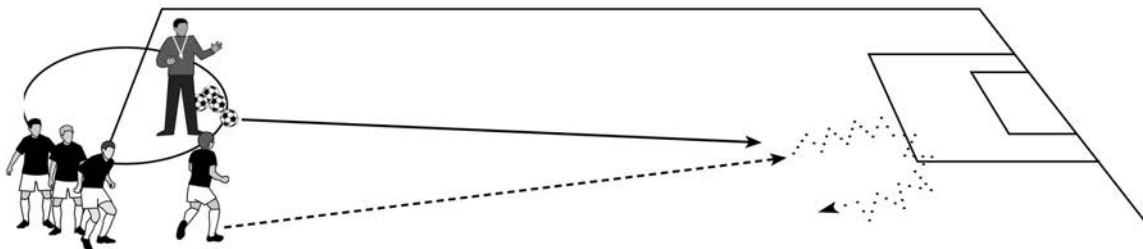

3. Repeat (B) above with goalkeeper adding verbal instructions.
 - “Turn” — i.e., no pressure, turn the ball up-field.
 - “Back to goalie” — pass back to goalkeeper at outside of post. Defending player then breaks to touch-line to receive goalkeeper kick.
4. Coach or server feeds balls to two players of the same team. Player nearest ball collects (“I have it”) then takes outside position and teammate assumes supporting position. Player with ball dribbles to return ball to midfield. No pass.

Figure 15-21

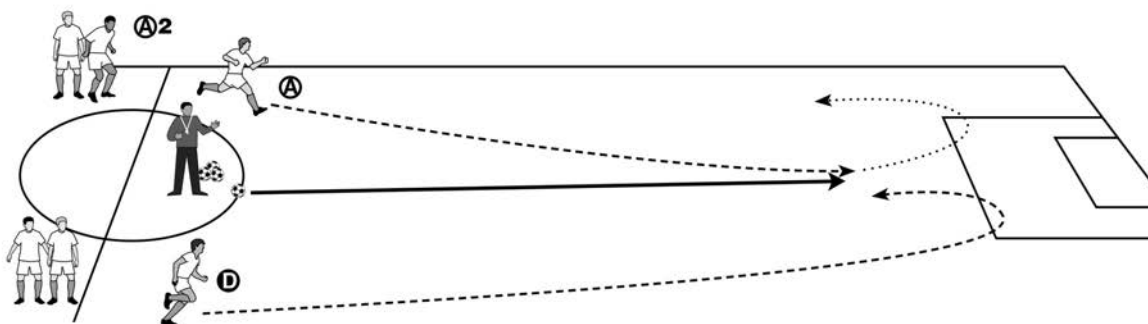

5. Add active opponent A. Add constraint that dribbler D-1 loses ball to A. Forces D-2 to realize player must be prepared to support (provide depth) to counter attack in event of failure.
6. Add goalkeeper who directs players as in (C) above. Remove constraints from all players.
7. Coach or server feeds balls. Three players on the same team go for the ball. The player (D-1) nearest the ball takes possession (“I have it”). Player becomes the attacker and repeats step 1 (no pass). The player nearest the goal calls “support” and provides mobility and overlaps around the attacker towards the outside calling, “overlap.” D-3 overlaps around D-1 to
 - prevent obstruction of A.
 - give D-1 clearer view of play.
 - be prepared

Figure 15-22

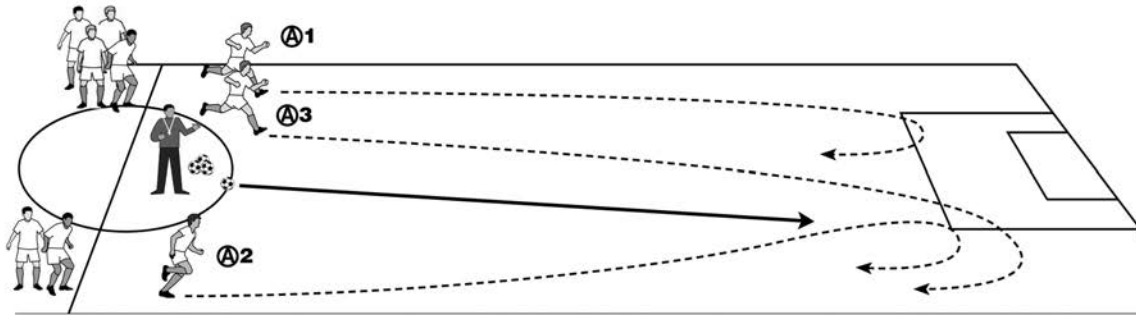

8. Add passive defender D - i.e., attacks A-1 (constraint!). A-1 passes to overlapping.

9. Let D go active - attacks or marks any player. Reiterate options for A-1:

- Pass to A-3.
- Pass back to A-2 or goalkeeper. (Goalkeeper can only kick.)
- Pass forward to midfield (coach).
- Keep ball - beat A with dribble (dangerous).
- Clear ball.

10. Add another opponent D-2. Repeat (I) above.

Note: Coaches should note similarity between (I) above, and 3 vs. 1 in attacking methods. Discuss merits of different approaches to option training.

Counter attack from defense

It is important that we teach our defenders the transition from defending responsibilities to attacking responsibilities. Many goals may be scored by quick transition from defending to attacking with use of quick passing and running. When training the defense in a 5 vs. 4 or 6 vs. 4 scrimmage, provide counter attack goals for the defense as shown below.

Figure 15-23

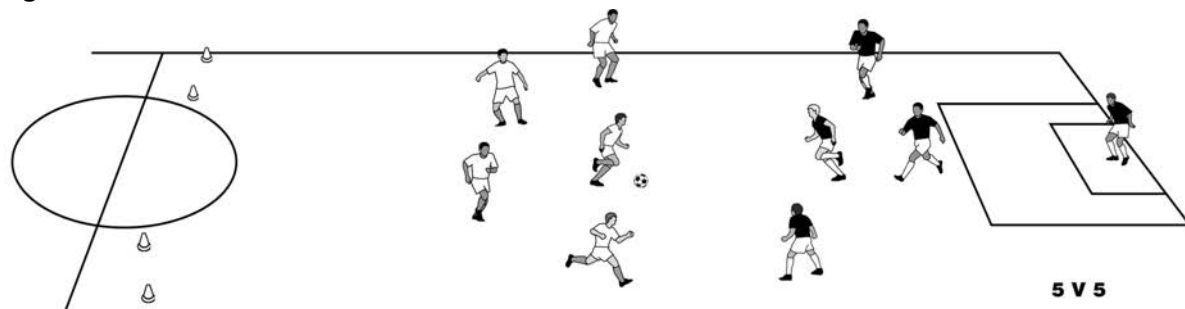

When the defense wins possession, encourage them to counter attack to one of the small goals. Emphasize, however, that no unnecessary risks should be taken and that maintaining possession is the first objective. This type of play also teaches the value to team A of holding an attacker back to prevent a counter attack. A variation of this theme is to provide a target player for the defense to play to. The ball must go to the target player before the counter attack may begin.



Man-to-Man Defense

The main premise of man-to-man defense is that every attacker must be covered. When the ball changes and the attack develops, the defenders must take up goal side and ball side positions on their designated opponents. Good marking techniques must be employed (see section on marking). True man-to-man marking requires the defenders to follow their opponents wherever they go. This can create holes in the defense that a good team may exploit.

The success of the man-to-man defense comes down to the success of the 1 vs. 1 confrontations that result. Teams should consider a man-to-man defense if the defenders physically and athletically match well with opposing attackers. If the defender's speed, skill, and tactical awareness match those of his opponent, man-to-man is a reasonable choice.

The man-to-man defense gives responsibility to the individual defenders for their opponents' actions. Clear delineation of these responsibilities makes it easy for the defenders to make correct choices about their play within the team and results in a more effective "team" defense. Bear in mind that some players cannot handle this much responsibility.

During the game, coaches should look for player mismatches or defenders whose concentration is not on the opponent. This type of defense works well with the use of a sweeper or free-back who does not have a marking assignment. The sweeper can provide support for any of the defenders.

Zone defense

In a zone defense, the defenders cover an area of the field rather than an opponent. The defender is instructed to mark any opponent coming into the zone. This concept is easier for the young player to learn and execute. The 3-back pivoting defense is an example of this type of defense. Players without the physical ability of the attacking player may perform very effectively in a zone defense. Zone play can become complicated if players run from one zone to another and defenders must "pass off" the coverage to a defender in the next zone. Communication is still the best tool to use if there is indecision. Players must mark tightly near the goal, even in a zone defense.

Most teams use a combination of both man-to-man and zone defense. The midfield playing zone defense and the defenders man-to-man is one example of a combination defense. No matter what defense is utilized; player understanding and execution is the key to success.

Attacking Methods

In this section we will provide examples of the type of training necessary to teach players the attacking principles of play. For young players the best training situation involves small group tactics because the decision making is simplified and the coaching points can best be demonstrated using smaller groups. As the players become more mature, the number of players involved in the tactical exercise may be increased. We build up the teaching of attacking tactics by using the methods previously described:

- free play
- structured drills for teaching small groups
- small-sided games where decision making and problem solving are applied.

Always keep in mind that player tactical development is no substitute for player skill development. Only after a player achieves the proper skill level should the next step, of applying these basic skills in an intelligent manner, be attempted. Always take the opportunity to simultaneously coach the defenders. A certain number of tactical points are best made in specific drills and games oriented toward defense. However, in the build-up of attacking tactics using small-sided games, there is ample opportunity to introduce defending counter measures, but keep in mind that the coaching emphasis of the session is attacking play.

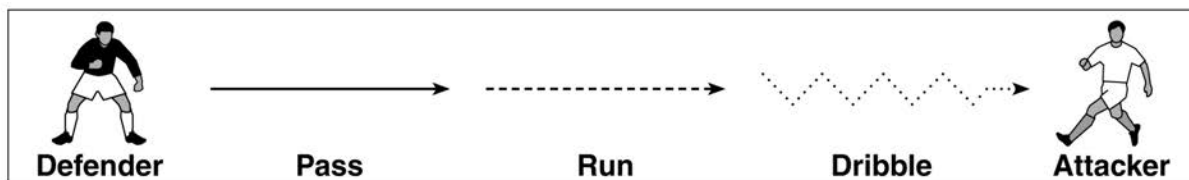

1 vs. 1

The principle of play being stressed here is the concept of penetration. The section on dribbling described many of the tactical points involved with beating an opponent. The coach should give players the opportunity to work on individual attacking play at each practice. Stress that, when in the attacking third of the field, players should look to beat an opponent with the dribble when there is no supporting defender or the defender is not in the proper position. To keep practice interesting, organize a series of challenge matches between the players. Keep track of wins and losses. Give two points for a win, one for a tie and zero points for a loss.

2 vs. 1

This is the fundamental grouping in soccer. The primary principle of play which is being addressed here is attacking depth or support by the second attacker. There are several different two-player combinations that will be discussed in this section. The first requirement for the successful execution of any 2 vs. 1 option is player recognition. Technical execution is built up in drills, but players must first recognize that the play is on. An attacking player with the ball combined with a teammate to beat an opponent is one option. After instructing 2 vs. 1 techniques, always let the players take what they have learned into a small-sided game to apply the techniques and make decisions.

Build-up 2 vs. 1

- Warm up using pair passing.
- Free play 2 vs. 1 - group critique of free play - emphasize movement of supporting player.
- Conditioned game of 2 vs. 1 - defender faces the player off the ball. Player off the ball must work to get free by feinting and then run to open space to receive pass. Main point is that player off ball must work to provide safe passing angles.
- Return to free play - encourage players to open up distance to run defenders (third attacking principle of width in attack).
- Use a grid to build skills by restricting space to simulate match pressure. Emphasis is on fast ball movement and player off the ball moving to open space. With player success, add one-touch play, outside of foot passing, takeovers, etc. Have players develop concept of soft ball played into space and hard ball played to feet.

An additional example of 2 vs. 1 grid play is shown in Figure 16-1. A-1 and A-2 play against a single defender while they try to cross the end line with the ball under close control. Players are not allowed to dribble past the defender. The defender must challenge for the ball in the opponents' grid. Ignore the offside rule. Length and width of the grids may be varied to achieve the correct level of pressure.

Figure 16-1

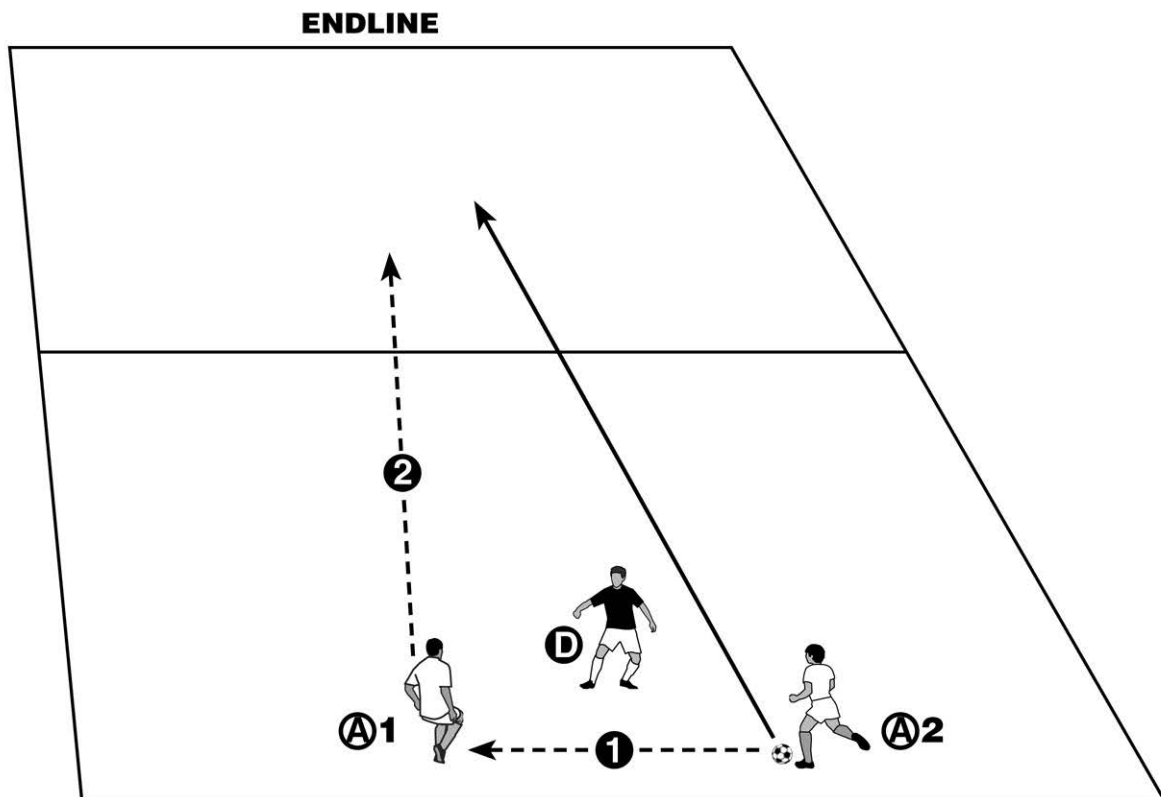

Combination Play

The primary task of the attacking team is to get the ball behind the defense to create defensive problems which can result in scoring chances. The run/pass movements employed by two or more attacking players in challenging the defense are called combination plays. In general, these plays involve simple coordinated runs and passes which result from player recognition of the field situation. Several simple two-player combination plays will be discussed here, such as the wall pass and the give-and-go.

Wall Pass

The wall pass is the basic two-player combination play. As shown in Figure 16-2, an attacking player with the ball, A-1, attempts to beat a single defender with the help of a teammate, A-2. A-1 dribbles the ball toward the defender and, as the defender commits toward A-1, the ball is passed to A-2. A-2 then plays a one touch ball into space behind the defender for A-1 to collect. The concept is simple. Here are a few cues for executing a successful wall pass.

- Recognition of the situation - players A-1 and A-2 must both recognize that a wall pass is an option.
- Aggressive defender - the defender must be committed to stopping the advance of A - 1 .
- Space behind the defender - space must be available behind the defender into which A-2 may successfully play the ball.
- Proper positioning of A-2 - player A-2 must be positioned in line with the defender. If the defender moves, then A-2 must move.
- Proper technique - player A-1 must deliver a properly weighted pass to the feet of A-2, who must deliver a first-time pass into space behind the defender.
- Change of speed by A-1 - player A-1 must accelerate into the space behind the defender to receive the return pass from A-2.

Figure 16-2

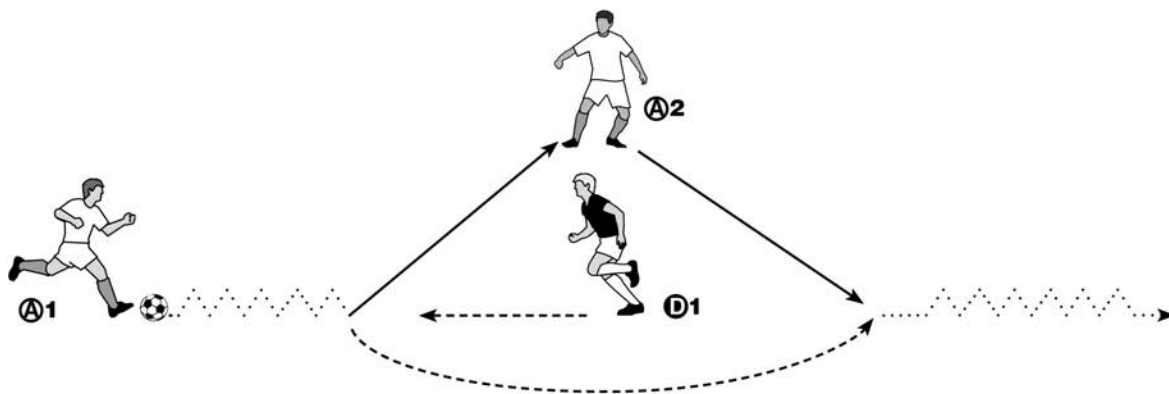

Wall Pass Build-up

As shown in Figure 16-3 below, two attacking players execute a wall pass with a cone taking the place of the defender. A-1 dribbles straight at the cone in a controlled manner. An accurate, properly weighted pass is made to A-2, who returns a one-touch pass into the space behind the cone for A-1. A-1 should be encouraged to -explode into the space. A-1 should immediately turn and repeat the exercise in the opposite direction.

Variations:

- Replace cone with a stationary defender.
- Allow the defender to take one step toward A-1. No tackling allowed.
- Allow defender to move freely which means wall must move freely.
- Vary distance of wall from the defender.
- Allow defender to move and tackle.

Figure 16-3

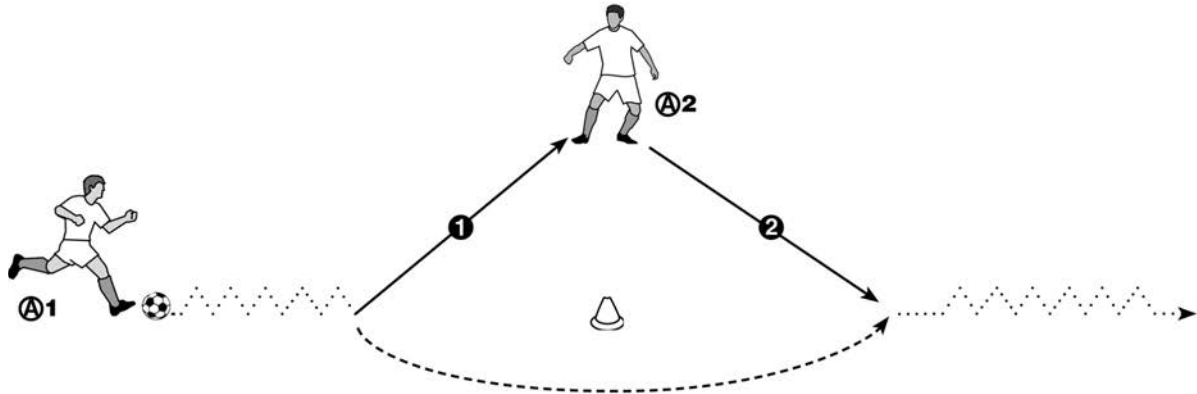

A similar exercise which trains the mechanics of the wall pass is shown in Figure 16-4. Several attacking players execute wall passes against a single defender. A-1 dribbles toward and commits the defender. A wall pass is executed and the ball is played to A-3. A-3 attacks the defender and executes a wall pass with A-2, and after controlling the return pass, plays the ball to A-4. Variations can include making all passes one or two-touch.

Figure 16-4

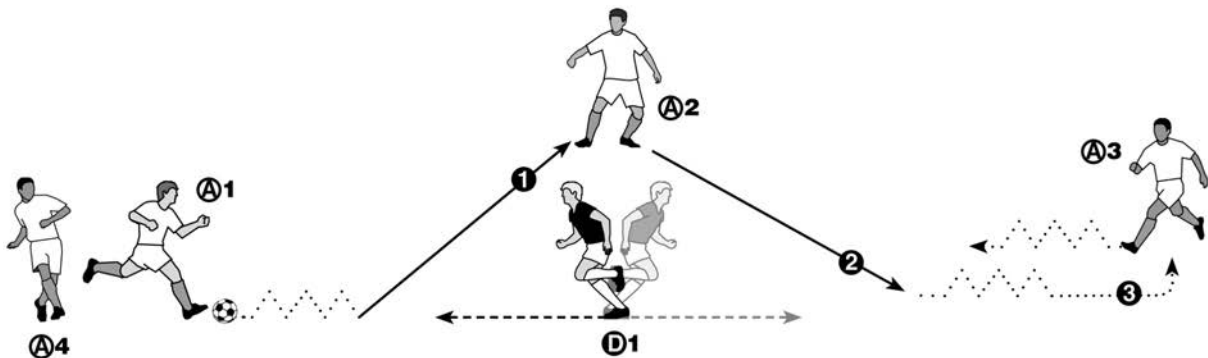

Wall Pass Option Training

Two sets of players are arranged as shown in Figure 16-5. A-1 and A-2 are five yards apart while the group containing A-3 and A-4 are five to ten yards from A-1 and A-2. A-1 attacks A-3 and has the option of executing a wall pass with A-4 or using the dribble to beat A-3. In the figure, A-1 chose to execute a wall pass with A-4. A-2 now begins to attack A-4 and has the same two options. A-2 chose to beat A-4 with the dribble. A-1 and A-2 then repeat the exercise in the opposite direction. The defending players A3 and A-4 should not chase once they are beaten. Keep the pace of the exercise steady to achieve maximum number of repetitions.

Figure 16-5

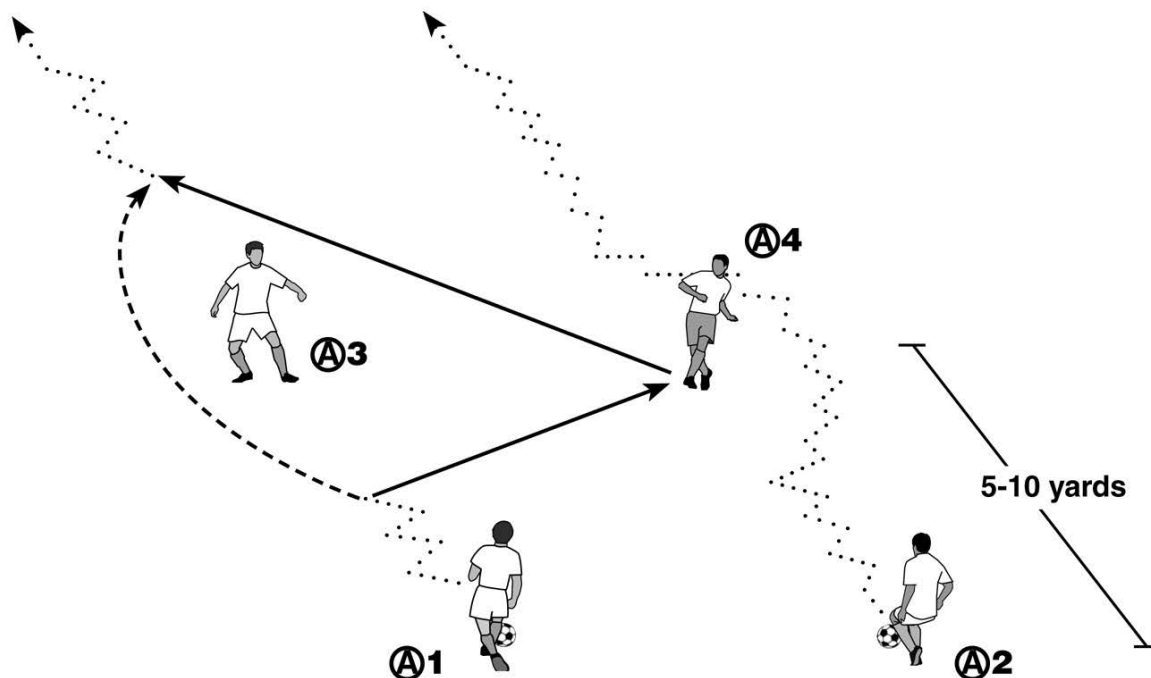

Give-and-Go

The give-and-go is another two-player combination play. As shown in Figure 16-6, the player A-2 is playing with back to the defender and the goal. Player A-1 plays the ball to the feet of A-2 and follows the pass with a run into space for a return pass. After receiving the return pass, A-1 may choose to advance the ball by pass (pass 3) or to play back to A-2 who has made a blindside run behind the defender (pass 4). A blindside run is a movement by an attacking player away from the view of the defender who may be watching the ball.

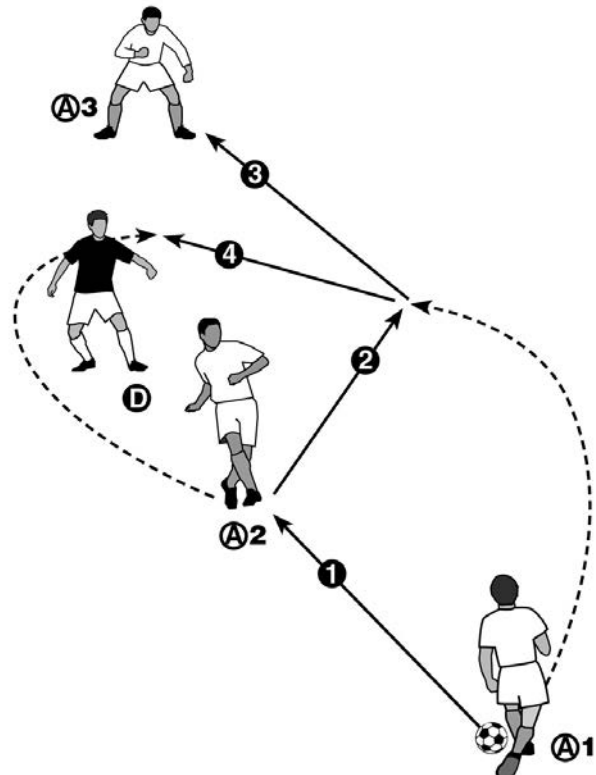
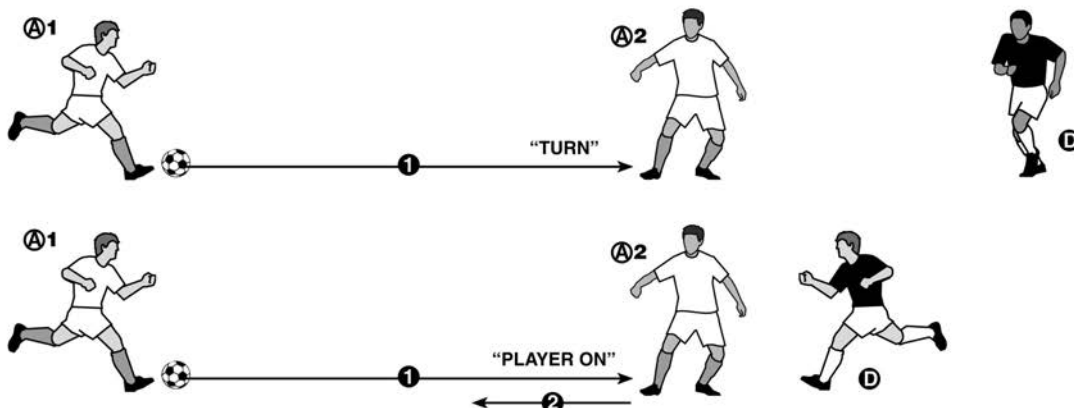

Figure 16-6

Build-up Give-and-Go

The build-up for developing the give-and-go can begin as shown in the following exercise. Consider the situation shown in Figure 16-7 where A-1 passes to A-2. If the defender lays off, A-2 is told by A-1 to TURN. This lets A-2 know that space is available to turn and face D for a shot or another advancement opportunity. If the defender marks A-2 tightly then A-1 calls MAN ON which allows A-2 to return the ball to A-1. We are trying to train players to receive the ball with their backs to defenders and to establish the necessary communication between teammates to execute a successful combination play.

Figure 16-7



The build-up for developing the give-and-go continues with three players aligned as shown in Figure 16-8. A-1 passes to A-2 who controls on the turn and passes to A-3. As a beginning, require A-2 to control using the inside of the foot. Receive and turn -with the ball, do not stop it. On the turn, the head comes up to locate the passing target. Encourage A-2 to play the ball forward to A-3 with the next touch. The exercise is repeated in the opposite direction. Vary the controlling foot left and right.

Figure 16-8



Variations:

- A-2 moves to meet the ball.
- Passive defender on the shoulder of A-2.

The second phase of the build-up is characterized by the supporting run into space by A-1 to receive a return pass. This run by the supporting player is providing width to the attack. The organization is shown in Figure 16-9. A-1 passes to A-2 who is marked by a cone representing the defender. A-2 returns the pass to A-1 who is sprinting into open space on the outside of A-2 as shown. As a variation, allow A-2 to move away from the defender and toward A-1 to receive the pass. A-1 should then deliver the pass upon sudden movement by A-2.

Figure 16-9

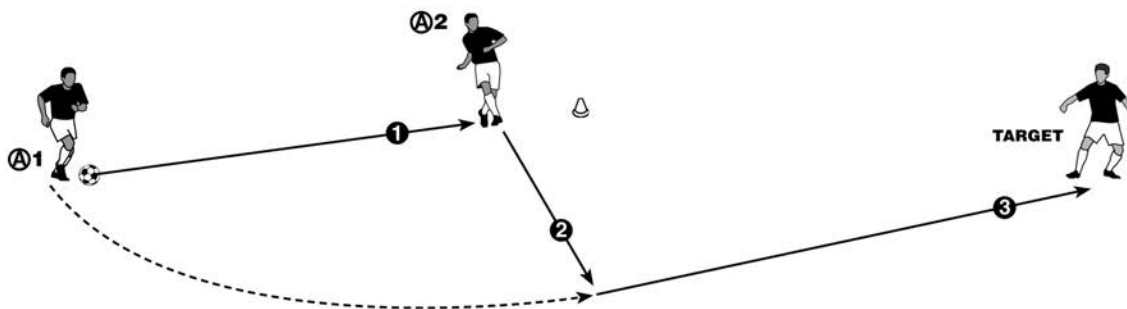

Variations:

- Vary distances for passes 1 and 2.
- Allow pass 1 to be in the air.
- Allow ball to be delivered one or two-touch to a target player T downfield.
- Allow A-1 to shoot on goal after receiving pass from A-2.

Figure 16-10

At this time we can introduce the concept of the check-in/check-out move by A-2 to create space for self. The organization is shown in Figure 16-11. A-2 must drive back on the defender giving the impression that a long ball is being delivered (check-in move). When the defender (D) begins to accelerate, A-2 changes direction and runs back toward A-1 at a 45 degree angle (check-out move). This action creates playing space by A-2 for A-2. The sudden change of movement back toward A-1 is the signal for A-1 to deliver the ball.

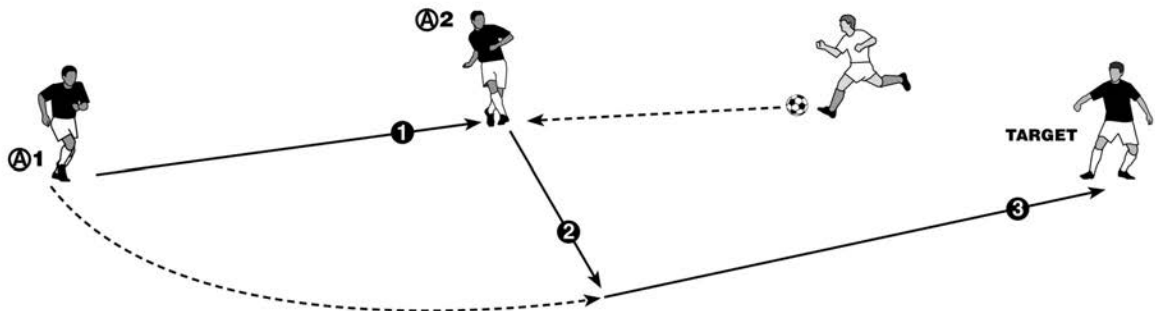
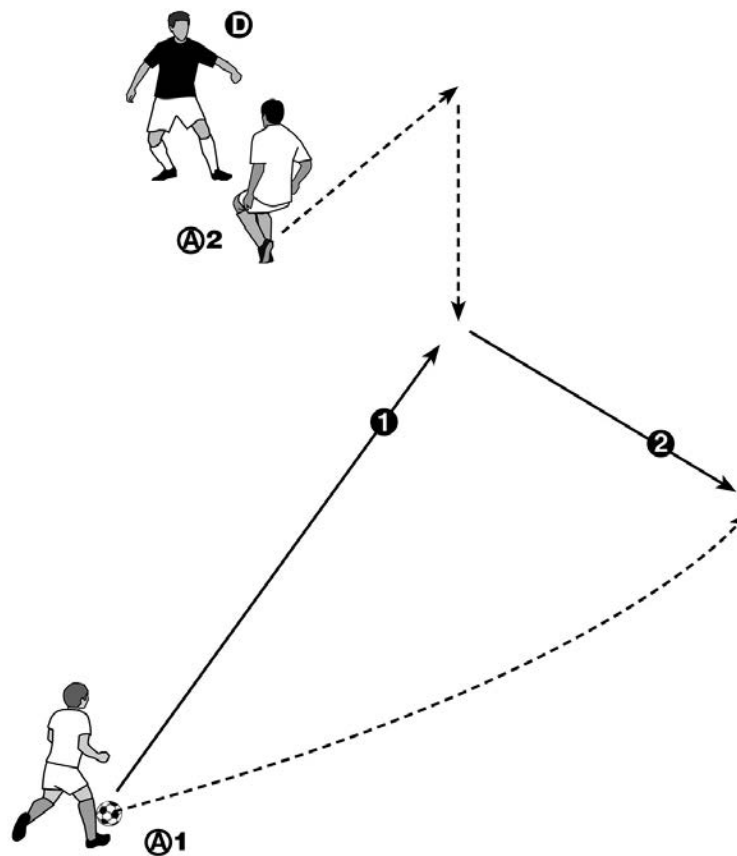

Figure 16-11



We can continue this development by adding the blind side run option. A-2 runs the check-in/check-out series against D. A-1 delivers the ball and moves to take the return pass. After delivering a one-touch pass, pass 2, A-2 turns away from the direction of the pass and runs on the blind side of D to move into an advanced position to receive pass 3. This run is considered to be blind side since D will probably watch the pass made by A-2. The run itself is a bending or curved run. A-2 may now shoot at goal or combine with another player. See Figure 16-12.

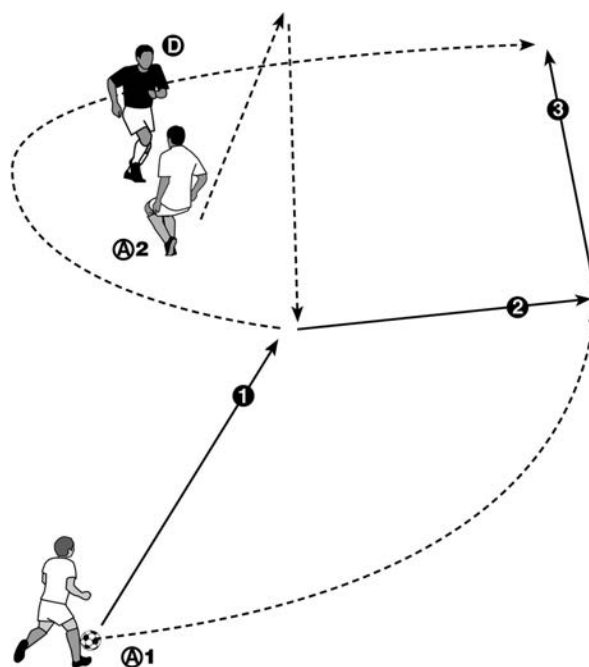
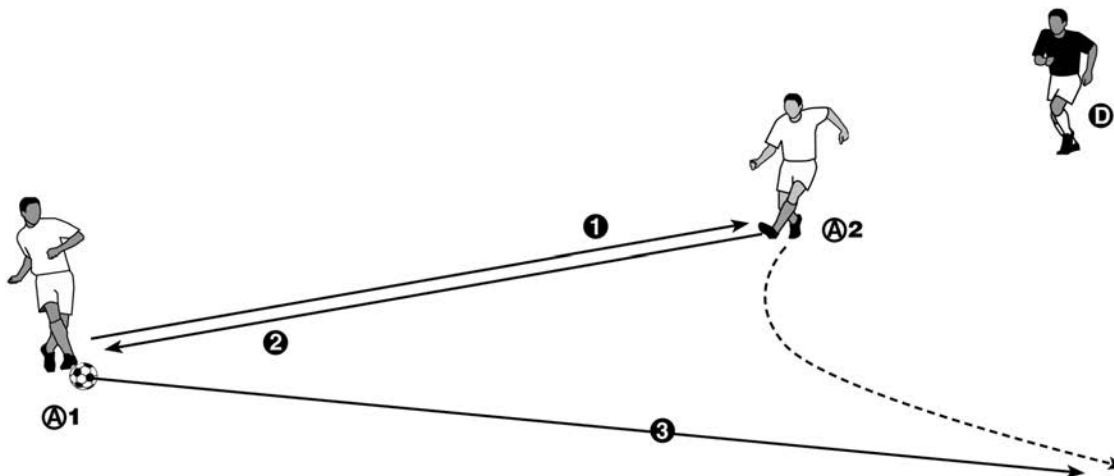

Figure 16-12

A second option similar to the give-and-go is the double pass where A-2 returns the ball to A-1 and sprints to the side to receive a return pass. See Figure 16-13.

Figure 16-13



Variations:

- Vary distances of passes.
- Deliver pass -1 in the air.
- Allow shot on goal when defender is beaten.
- Introduce check-in/check-out moves.

Take Over

The take-over is a 2 vs. 1 tactic that players may execute to change direction of the play to exchange possession in situations where a pass is inappropriate, or to maintain possession when under pressure. The take-over is generally executed by players performing a crossing maneuver with a defender pressuring the player with the ball. The player with the ball always remains between the defender and the supporting player as shown in Figure 16-14. The ball, as usual, should be controlled with the foot farthest from the defender. As the supporting player approaches, the controlling foot is removed from the ball and the supporting player dribbles the ball away. If the ball is being controlled with the right foot then the ball is taken by the supporting player with their right foot. If the left is being used then the ball is taken with the left. It is important that the ball is taken by A-2 and it is not passed from A-1 to A-2.

Figure 16-14

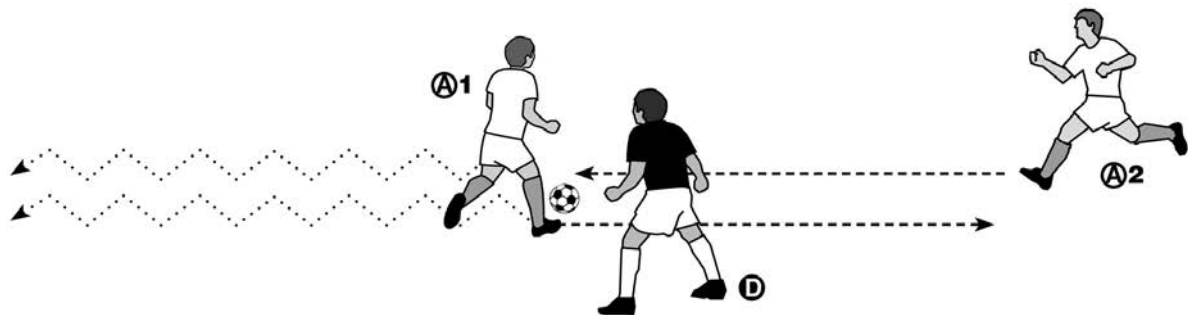

After the change in possession, both players should look to advance the ball into space behind the defender. One method of achieving advancement is the use of a blind-side run by the player giving up possession of the ball. In general, the defender will look toward A-2, momentarily forgetting about A-1. A-1 should immediately turn away from the direction of A-2's run and make a bending run into space for a return pass from A-2. (See Figure 16-15.)

Figure 16-15

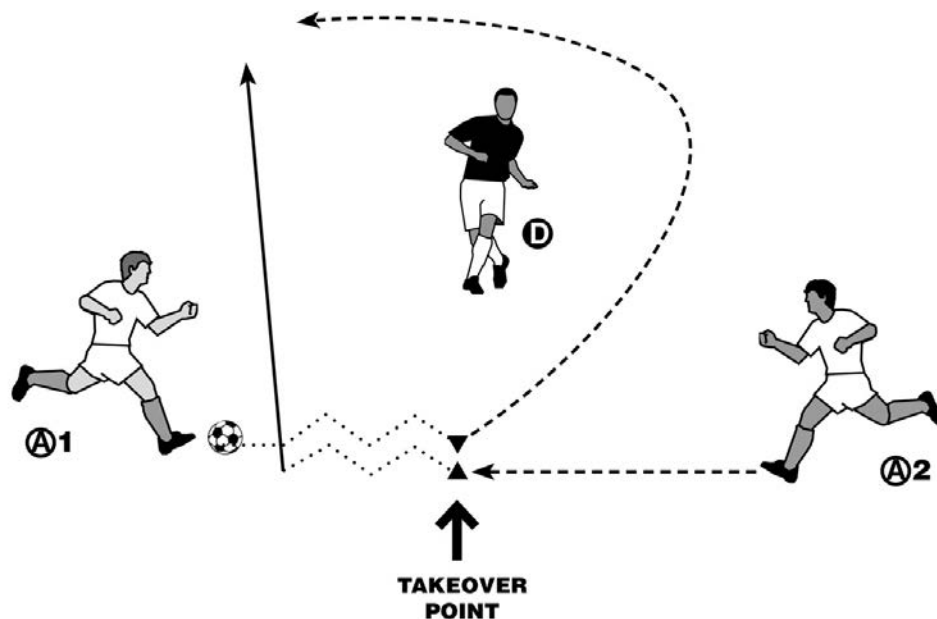

To build technique, organize players into two groups as shown in Figure 16-16. Player with ball dribbles ball on right foot as opposite player -takes over ball with right foot. The coaching emphasis is on close take-over and for the player taking the ball to develop a good controlling touch. Any subsequent play will depend on the ability of A-2 to play the ball quickly. Players should change sides to accommodate left foot take-over.

Figure 16-16

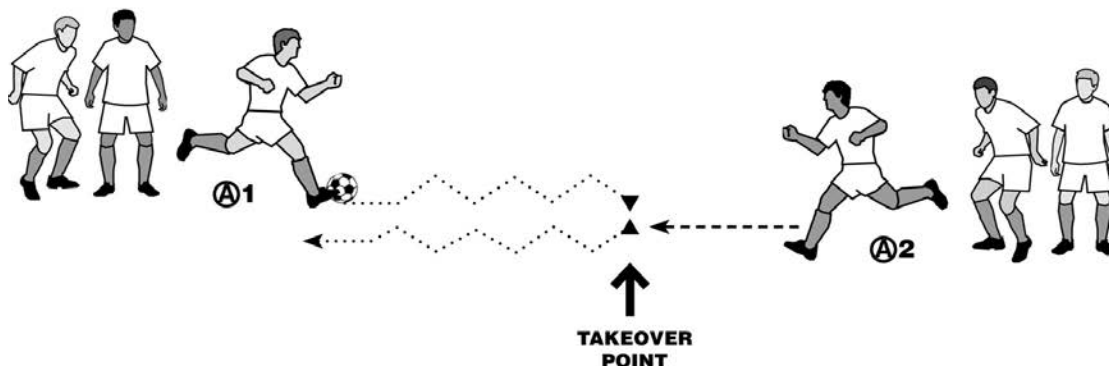

A defender can now be added to shadow A-1 and make the exercise more game related. As the players become accustomed to the defender, introduce the concept of advancement after the takeover and the blind-side run and pass. After the players have the technique and concept mastered, let them go to goal as shown in Figure 16-17. A conditioned game where points are awarded for takeovers (1 point) and advanced passes (1 point) can be fun and provide additional training.

Figure 16-17

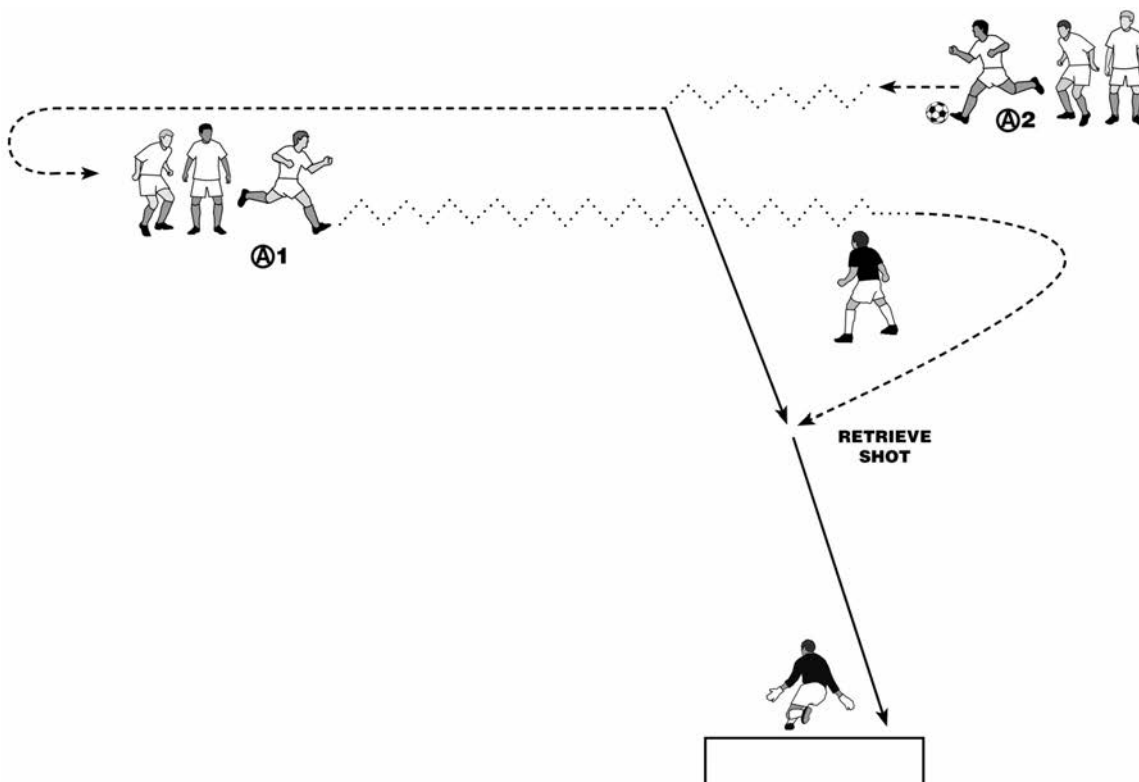

2 vs. 1 Summary

Each of the individual 2 vs. 1 options presented in this section should be introduced to the players by age twelve. It is beneficial in their development to put them into small-sided games where they can begin to make decisions regarding the application of each option. It should be remembered by the coach that dribbling and beating an opponent is also a viable 2 vs. 1 option and should be encouraged in the appropriate circumstances.

A helpful 2 vs. 1 game is presented in Figure 16-18. Two goals are defined 25-30 yards apart. These distances may be varied depending on the age of the players. Team A employs a goalkeeper and two forwards attacking team D with a goalkeeper and a single defender. A third player from team D rests behind the goal. As team A shoots or loses possession of the ball, the player shooting or losing the ball becomes the defender while the second team A player runs off the field behind their goal. The team D defender and goalkeeper immediately attack while the resting player moves into goal. Attacking players work on 2 vs. 1 combinations to develop shooting opportunities. The coach should let the players run through a few attacks before stopping them and reminding them of previous lessons. Two games may be run simultaneously to train the team.

Figure 16-18

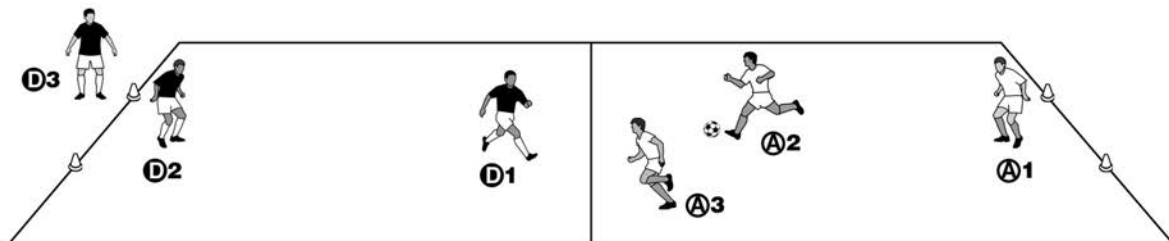

In addition to the small-sided game, a match condition drill can be used to train players to apply the 2 vs. 1 options learned. The basic concept of the drill is shown in Figure 16-19. The defender serves a long, high ball to two waiting attackers and then sprints to challenge them. If the defender can win the ball, the defender can score by passing through the cone goals. The attackers should control the long pass and attempt to score by applying 2 vs. 1 options learned.

Figure 16-19

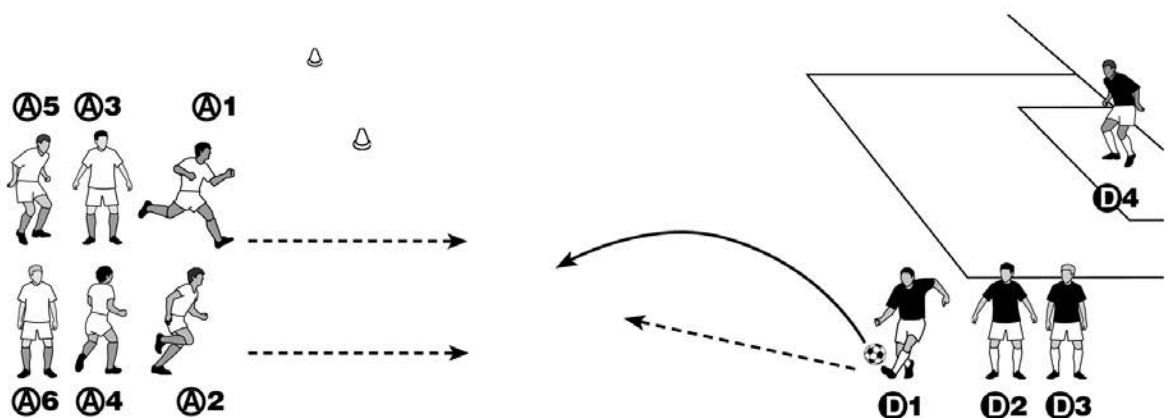

2 vs. 2

The training of attacking players in a 2 vs. 2 situation provides the basis of penetration and support play. In a 2 vs. 2 situation the supporting player is usually positioned behind the ball and at an angle as shown in Figure 16-20. As A-1 passes to A-2, the roles of the players switch and A-1 becomes the supporting attacker while A-2 takes on the penetrating attacker role. Players should understand that their roles must change as the ball is passed and possession changes. 2 vs. 2 provides the first opportunity to illustrate these points.

Figure 16-20

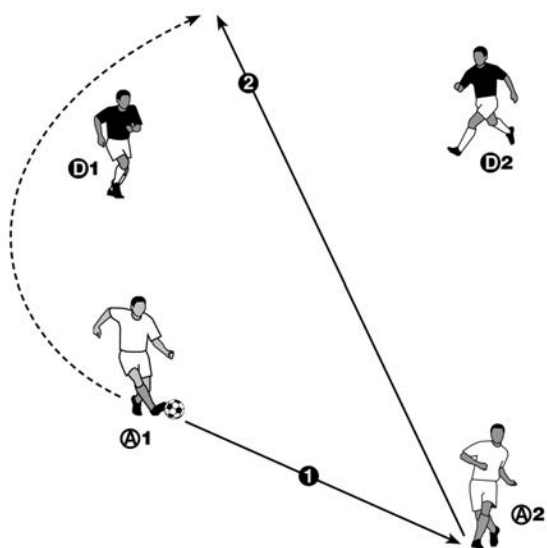
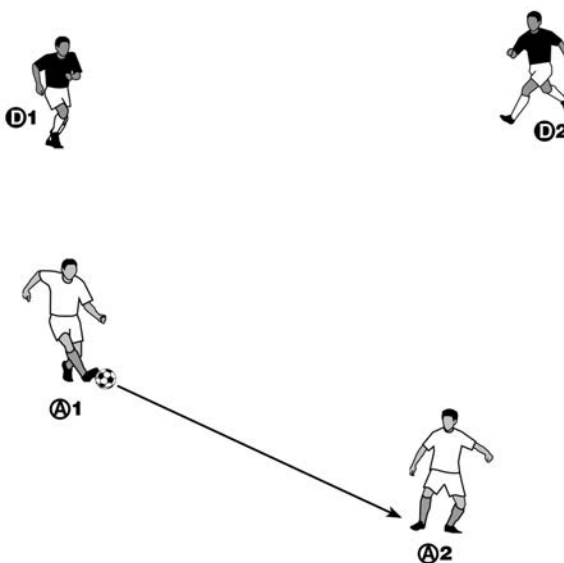

In order to be successful at 2 vs. 2, the players must be aware of the attacking options that can be used. Several of the most common options will be presented here. The most typical 2 vs. 2 attacking move is shown in Figure 16-21. A-1 passes the ball to A-2 and then sprints into space behind defender, D-1, while A-2 plays a one-touch through ball between the defenders. This option works well when D-1 is covering tightly and the supporting defender, D-2, is positioned too far away from the passing lane to prevent the through pass.

Figure 16-21

A second option occurs when the defense positions themselves incorrectly, as shown in Figure 16-22, providing attacking space behind the supporting defender. A-2 should look to move into that space when A-1 looks up and develops eye contact with A-2. The sudden acceleration of A-2 into the space is the call for the pass.

Figure 16-22

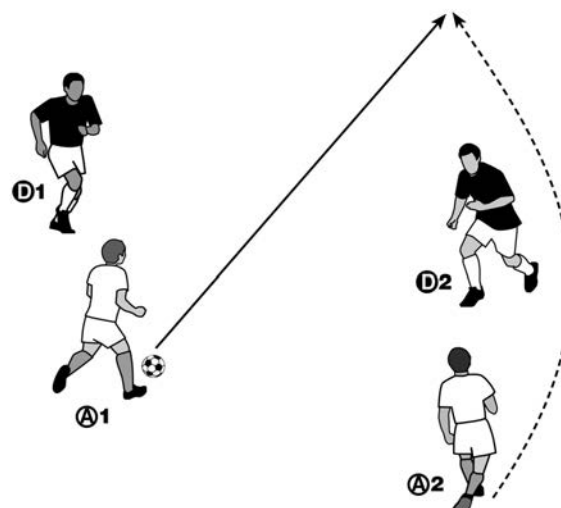

A third option is the use of the overlap by A-2 to move from one side of A-1 to the other (Fig. 16-23). The change of position by A-2 will cause a decision to be made by the defense regarding coverage and the possibility of a defensive mistake is increased. The overlap is behind A-1 so as not to preclude a pass forward and A-2 is still providing support if A-1 requires it.

Figure 16-23

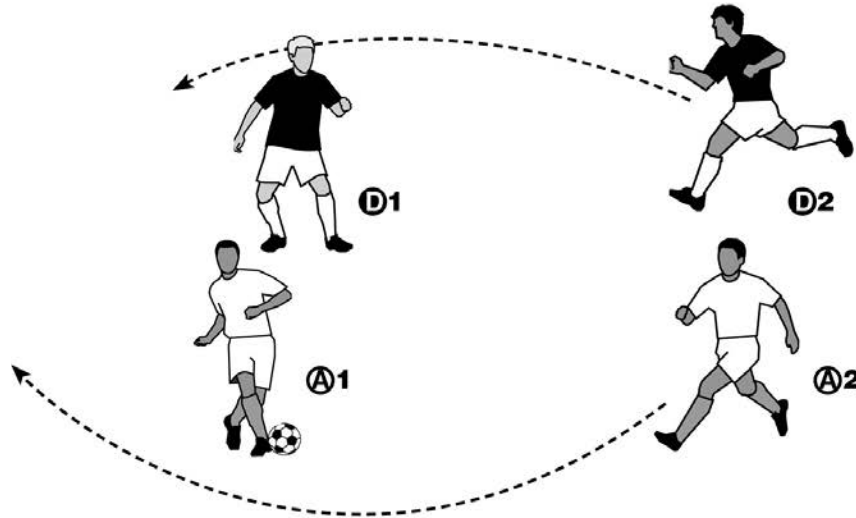

A fourth option is the use of a take-over to switch the direction of play quickly. This play is set up by the overlap movement discussed in option three. As the crossing maneuver takes place, it is possible that the defense will become confused, allowing player advancement to occur. This is shown in Figure 16-24.

Figure 16-24

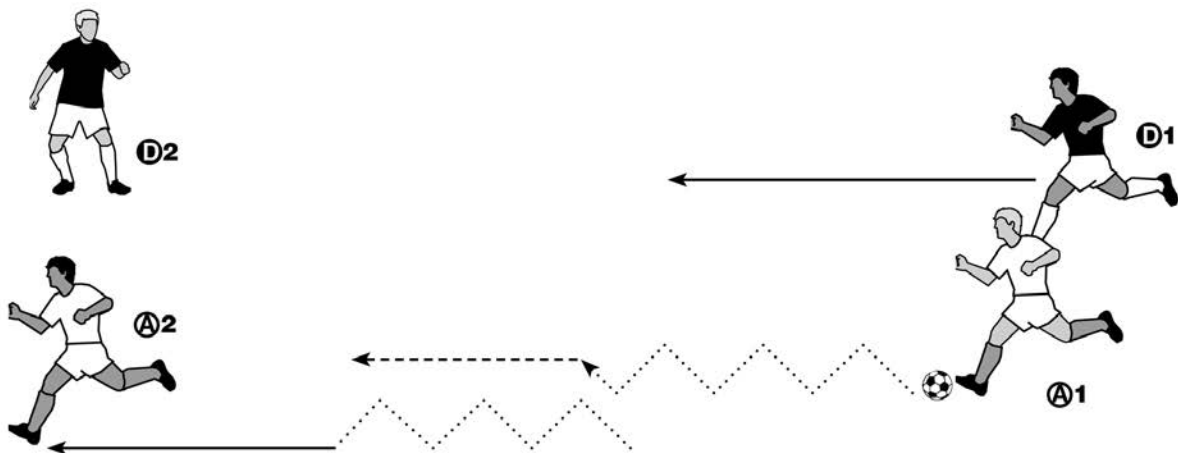

The final option to be discussed is the result of poor defensive positioning by D-2 (Figure 16-25). Player A2 has managed to pull D-2 away from a supporting position and A-1 has been presented the option of beating D-1 with the dribble without worry of D-2. This option will present itself very often until the defenders become aware of their roles.

Figure 16-25

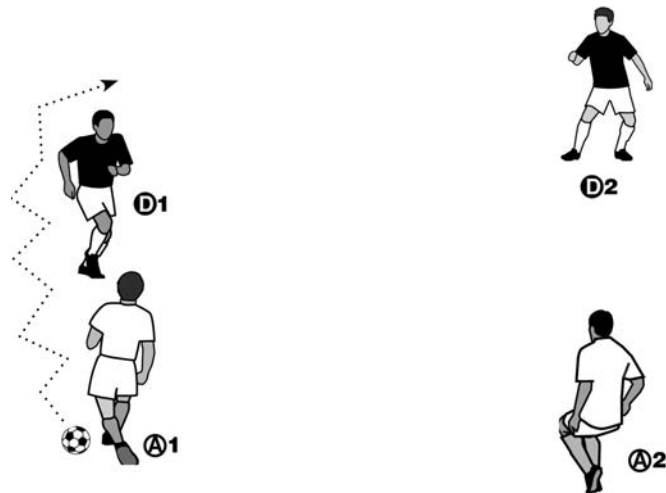

As players try to master these concepts, they will attempt to force passes and make runs at the wrong time. They will be impatient. As coaches, we must encourage patience as the players inter-pass the ball, looking for mistakes by the defense. In order to train players to understand and recognize these situations, they should be taught options one at a time, with the players spending time perfecting the technique of each one. As a new option is mastered, move into a small-sided game situation where the players can make decisions. An effective game for this purpose is 2 vs. 2 with goalkeepers in a grid 20 yards wide and 30 yards long. The grid size may be varied depending upon the age of the players. Players try to create scoring opportunities by applying lessons learned. As a variation, the goalkeepers may be removed and the players try to score in small goals (3 yards wide). A round robin tournament is an effective way to encourage the players to apply these concepts.

3 vs. 1

The training of 3 vs. 1 is a natural starting place for teaching attacking methods. The number of possible passing options (2) makes it possible for the young player to select a passing option and execute it at speed. The presence of a single defender takes some of the pressure from the attackers, which also allows the players more time to execute.

The presence of the third attacker allows us to begin teaching the attacking principles of mobility and width. The player with possession still has the job of penetrating the defense by dribbling or passing, and the second attacker must continue to provide support. These responsibilities do not change.

The build-up begins with a free play session where the coach allows the players to experiment with the 3 vs. 1 situation. After several minutes, the coach stops play and asks: "How many passes in a row?" The coach should emphasize that the tactical aspect of 3 vs. 1 is never to lose possession. This is accomplished by having the supporting players recognize the use of width and support in attack against a single defender.

The free play session is followed by the structured drill shown in Figure 16-26 to emphasize player movement off the ball. Three players are utilized in the exercise with each player located at the corner of the 10-yard square. The player with the ball should always have two passing options. As the ball is passed from A-1 to A-2, player A-3 must run to the open cone (space) to provide A-2 with the second passing option. Players continue to move to the open cone as the ball is inter-passed among the attackers. Begin the exercise with no opposition, but later introduce the single defender and adjust the size of the grid to insure success by the attackers. The defender should be encouraged to regain possession by pressuring the attacking players into making a mistake. Rotate attackers and defenders as necessary to keep up the pace of the exercise.

Return to free play and let the players apply the lessons learned in the drill. Count the number of successful passes and encourage players to beat the previous team best.

Figure 16-26

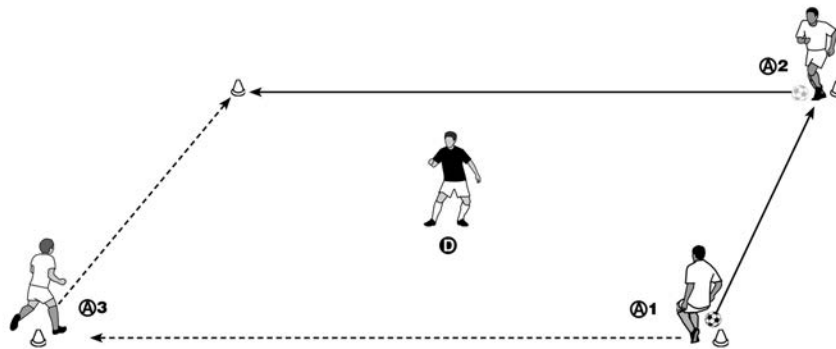

The previous exercise trains player movement to support the ball. We must now begin to address the angle of support relative to the ball. Let us return to the grid and previous organization. This time, however, players are allowed to run along the sides of the square, still moving from side to side providing two passing options (Figure 16-27). Running along the side provides the opportunity to instruct the angle of support. As the defender comes closer to A-1, the passing angle provided by A-2 and A-3 must become wider.

Figure 16-27

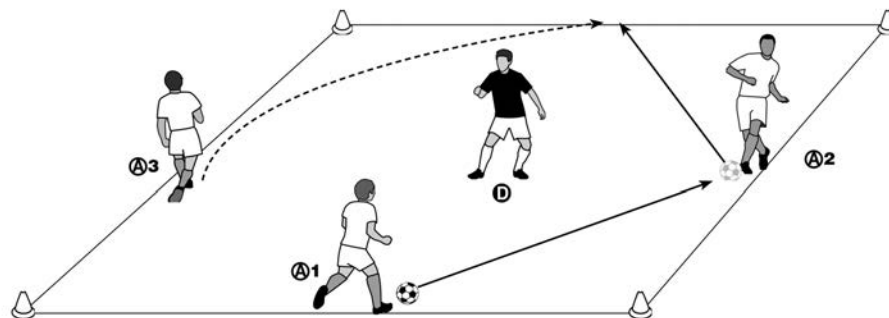

Play continues as in the previous drill with players running from side to side supporting the ball. If the defensive pressure becomes tight near the corner and two attacking players are in close proximity, encourage take-over opportunities. Adjust the size of the grid to insure player success. Count the number of successful passes (Figure 16-28).

Figure 16-28

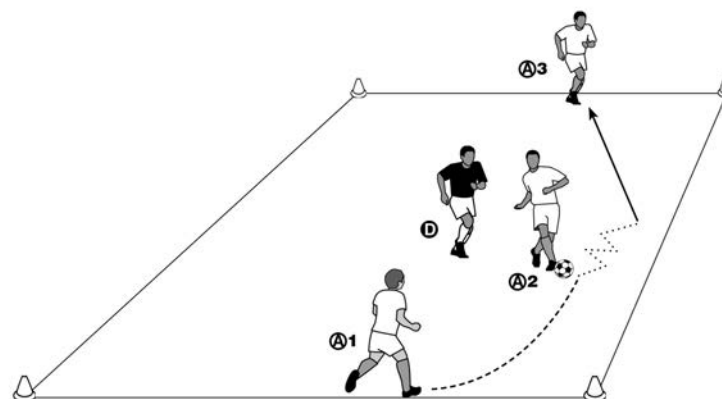

When players have the concept of proper supporting runs and passing angles, players may be allowed to play free within the confines of the grid. The coach should continue to emphasize the previous lessons. Continue to count the number of successful passes. (See Figure 16-29.)

Figure 16-29

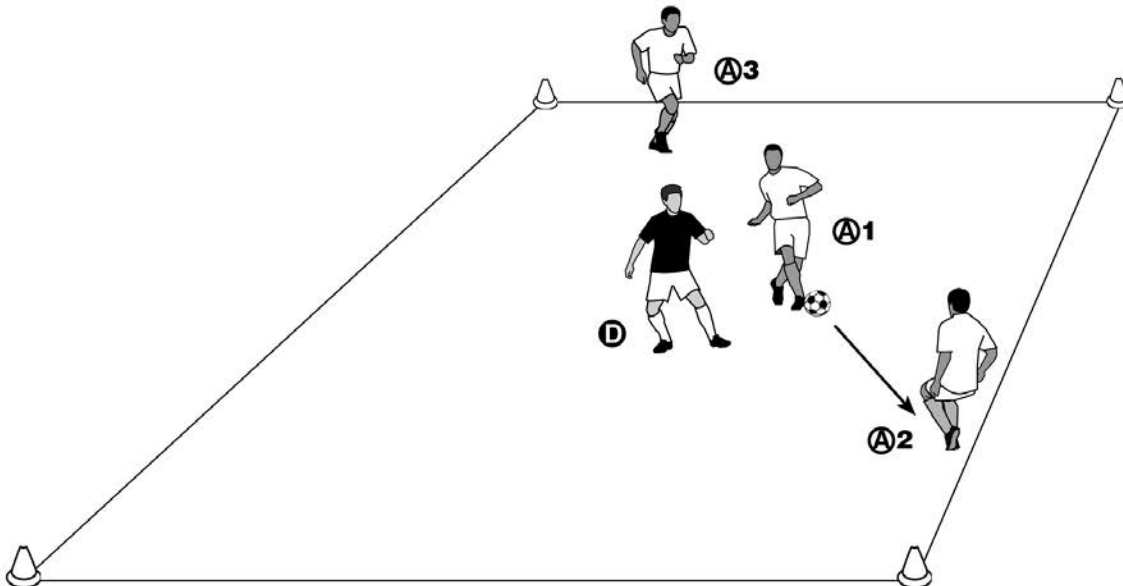

In Figure 16-30, we show a small-sided game for 3 vs. 1. Each team is composed of three players. Team A is attacking while player D-1 defends. Player D-2 acts as goalkeeper and D-3 rests. When team A loses possession, the player losing possession stays on as the defender while the two remaining teammates decide who is goalkeeper and who rests. Player D-1, upon winning possession, must decide whether to risk a quick counter attack or wait for D-2 and D-3 for a slow build-up. This exercise encourages transition play with player decision making. As a variation, play with both D-2 and D-3 acting as goalkeeper.

Figure 16-30

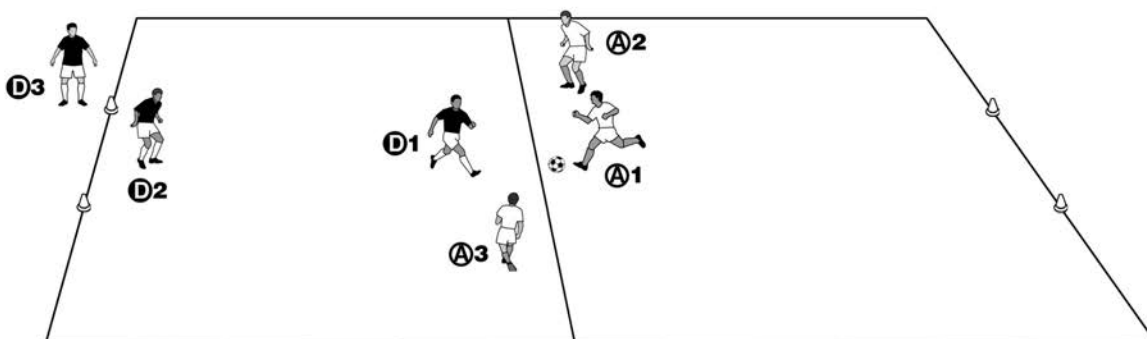

While possessing the ball is the objective of 3 vs. 1, the ultimate objective of the game is to get the ball down the field and into the goal. Therefore, we should train our players to look for advancement opportunities from the 3 vs. 1 situation. Let us begin with four attacking players and a square grid oriented as shown in Figure 16-31. Passes are made in sequence 13 when A-1 sends a long pass to A-4, who is acting as a target player. With the grid oriented as shown, player A-1 is in the best position to see the sudden movement of A-4, which is the signal to deliver the long pass. Timing of the run by A-4 should occur at the moment pass 3 is complete and A-1's head is coming up. Distance of A-4 should be based on the player's passing ability.

Figure 16-31

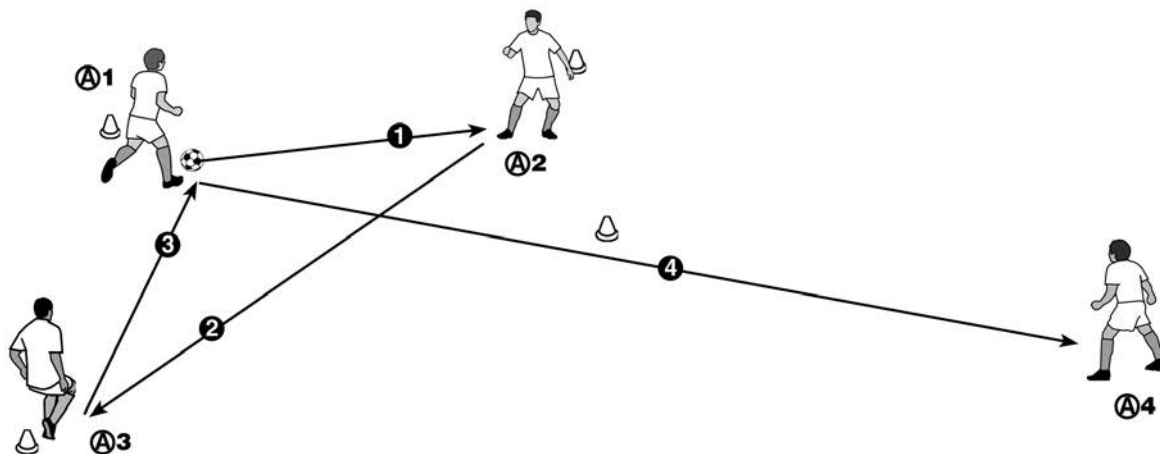

Players should now be allowed to play free in the grid without a defender and look for the opportunity to deliver the advancement pass to A-4. The player delivering the pass should be facing A-4 when they receive the ball in order to see A-4 call for the pass. A defender can be added to increase pressure. Remember, any of the attacking players may deliver the long pass. Adjust the size of the grid to achieve a successful delivery (as shown in Figure 16-32).

Figure 16-32

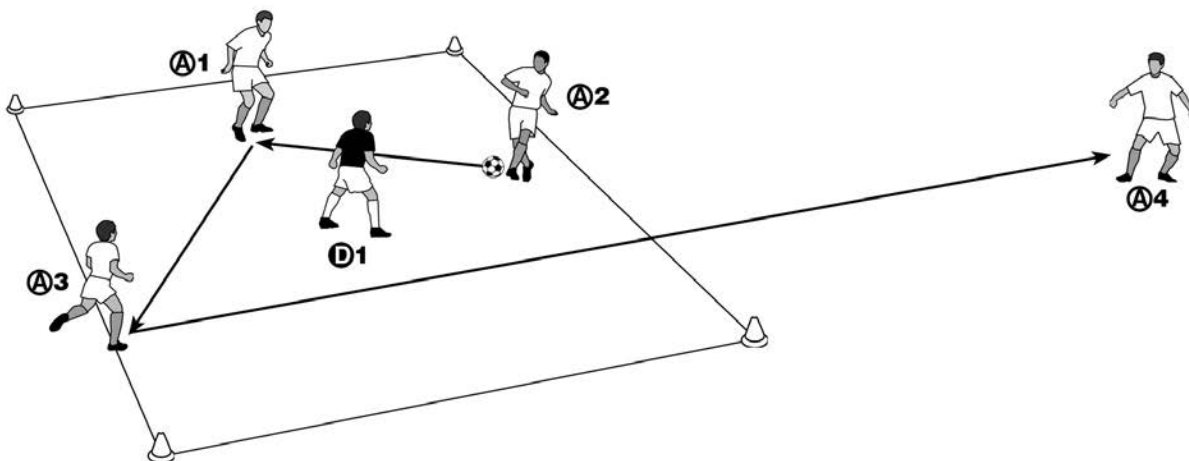

3 vs. 2

In most game situations, a 3 vs. 1, unless quickly finished, will turn into a 3 vs. 2. The amount of pressure on the attackers is quickly increased. The 3 vs. 2 ratio is very game-like, and older players should train for this situation.

The typical 3 vs. 2 situation is shown in Figure 16-33. The defender (D-1) is positioned to apply pressure to the ball and to stop the penetrating pass or dribble. The attackers, A-2 and A-3 are supporting A-1 with the necessary passing options.

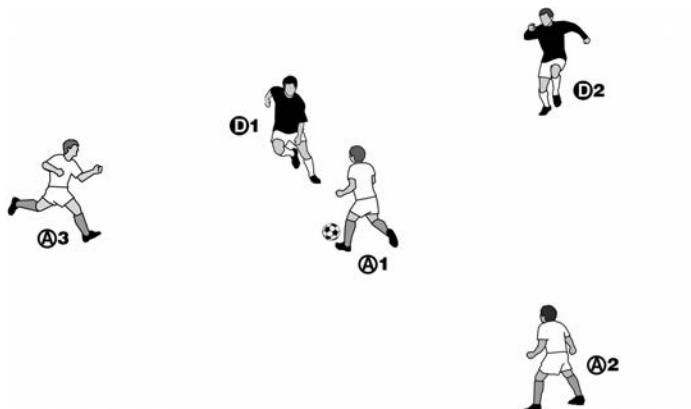
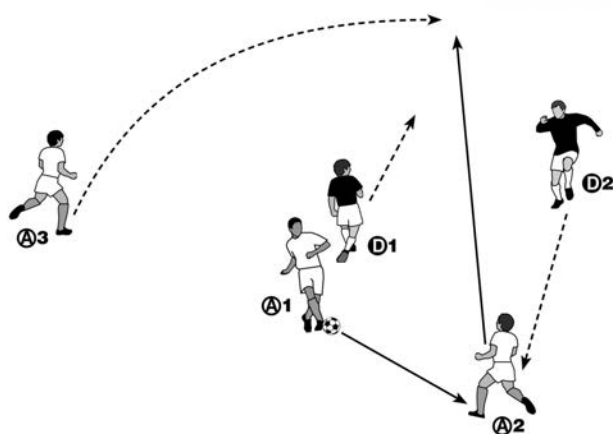

Figure 16-33



The fundamental attacking idea is to inter-pass among team A and draw the defenders square. A through pass between D-1 and D-2 is played to a running attacker. This is illustrated in Figure 16-34.

Figure 16-34

Three attackers play against two defenders in a 15 x 15 yard grid. Attacking players play at the corners and the defenders are positioned within the grid to deny the penetrating pass. The attacking objective is to deliver a diagonal pass whenever the opportunity is presented. Consider the following: A-2 passing to A-1. As the defense adjusts, A-1 plays the ball back to A-2. The defense may be caught square or flat so that the diagonal ball to A-3 may be delivered. A-3 and A-2 must recognize that the diagonal pass is on.

Figure 16-35

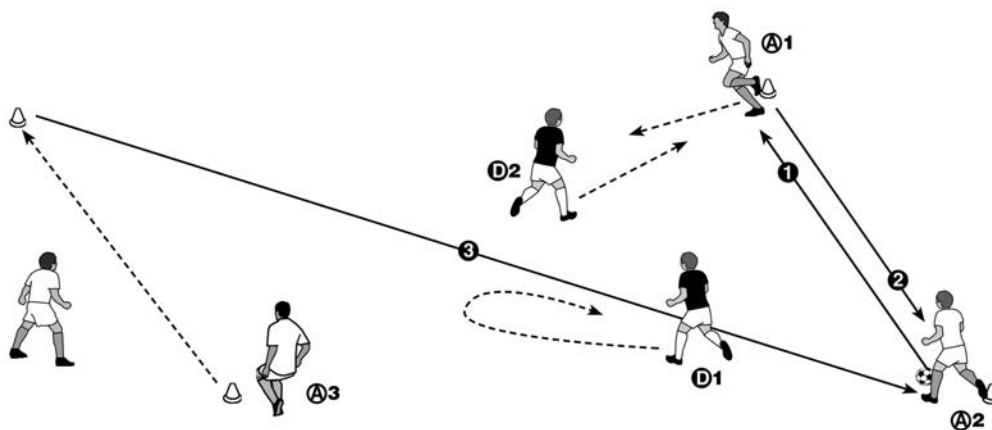

In keeping with the build-up presented for 3 vs. 1, we can move the players off the cones and onto the sides of the grid as shown in Figure 16-36. Reinforce the previous lessons of support and look for opportunities to penetrate the defenders. If the play becomes confined near a corner, use a take-over to relieve pressure.

Figure 16-36

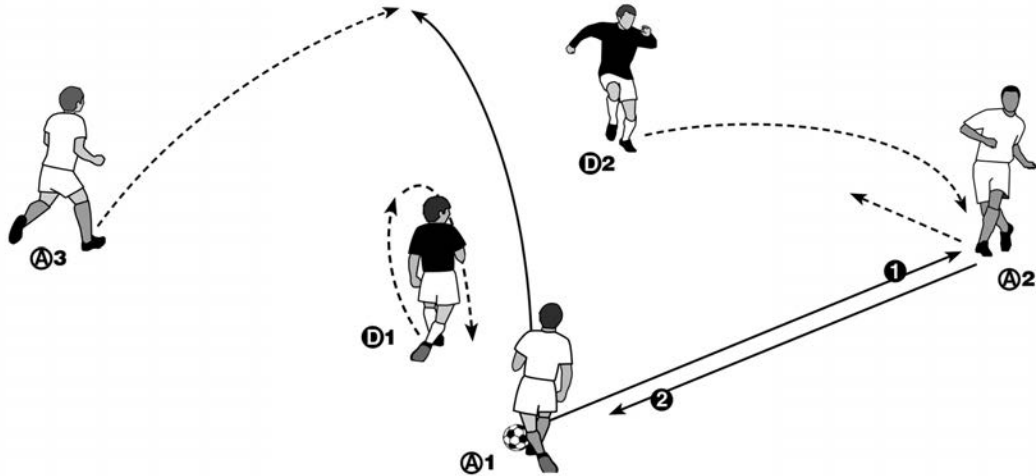

These ideas may be taken into a small-sided game. Each team is composed of three players. Team A is attacking while D-1 and D-2 defend. Player D-3 acts as the goalkeeper. When team A loses possession, two players stay on as defenders while the remaining player becomes goalkeeper. Players D-1 and D-2 must decide whether to risk a quick counter attack or wait for D-3 to begin a slow buildup (Figure 16-37).

Figure 16-37

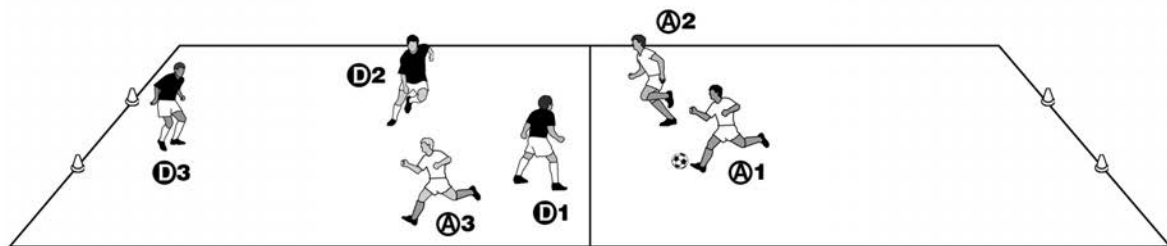

3 vs. 3

Once our players have become comfortable and have demonstrated an understanding of the attacking principles of play, it is appropriate to place them in a match-related situation. A small-sided game of 3 vs. 3 with goalkeepers or target players becomes the next step in the learning process. All of the attacking and defending principles of play are involved. The coach should allow the players to seek their own solutions to the problems presented. Reinforce all of the previous playing concepts.

Overlap Training

Overlapping should be performed when there is forward space to attack. In general, the run to space should be made by a player who is not acting as the primary support to the player in possession of the ball. Since overlapping may place a defender into an attacking position, and vice versa, all players must be trained in all aspects of the game.

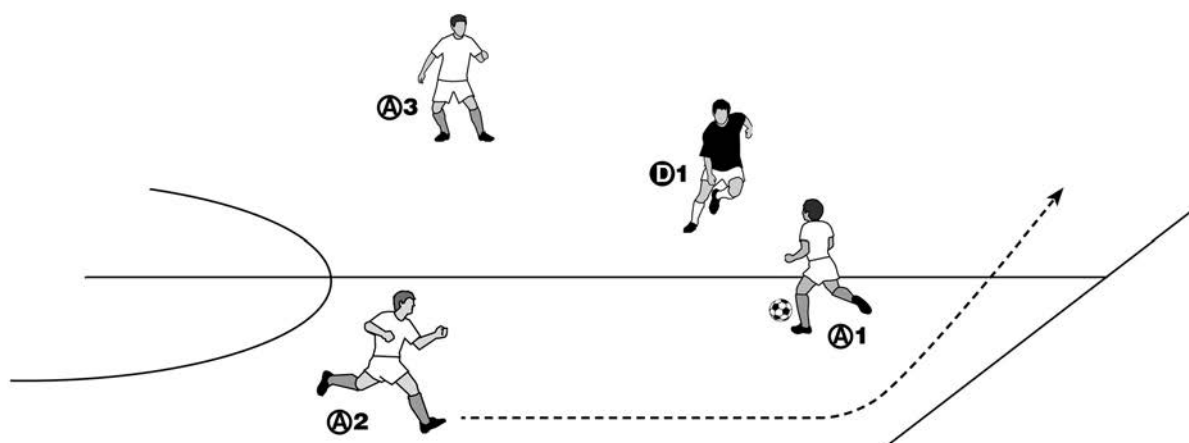

Figure 16-38

To begin the development of the overlap, it is important that players understand that when they make a pass that they must move rather than watch. Several warm-up exercises are available to reinforce this idea. As shown in Figure 16-39, players form a circle and pass to one another across the circle. When passing, the player follows the pass to take the place of the receiving teammate. Players change place continually. The coach can use this organization to work on passing and controlling techniques. As players become more proficient, an extra ball may be added.

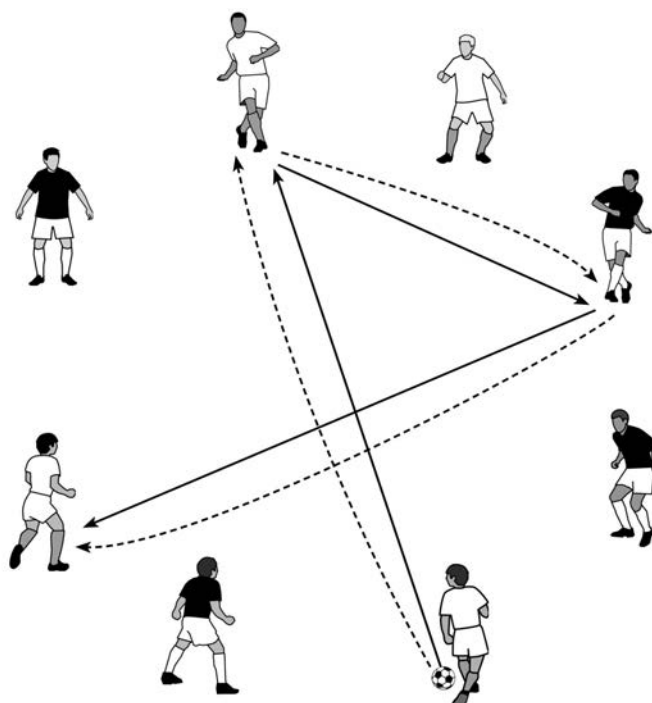
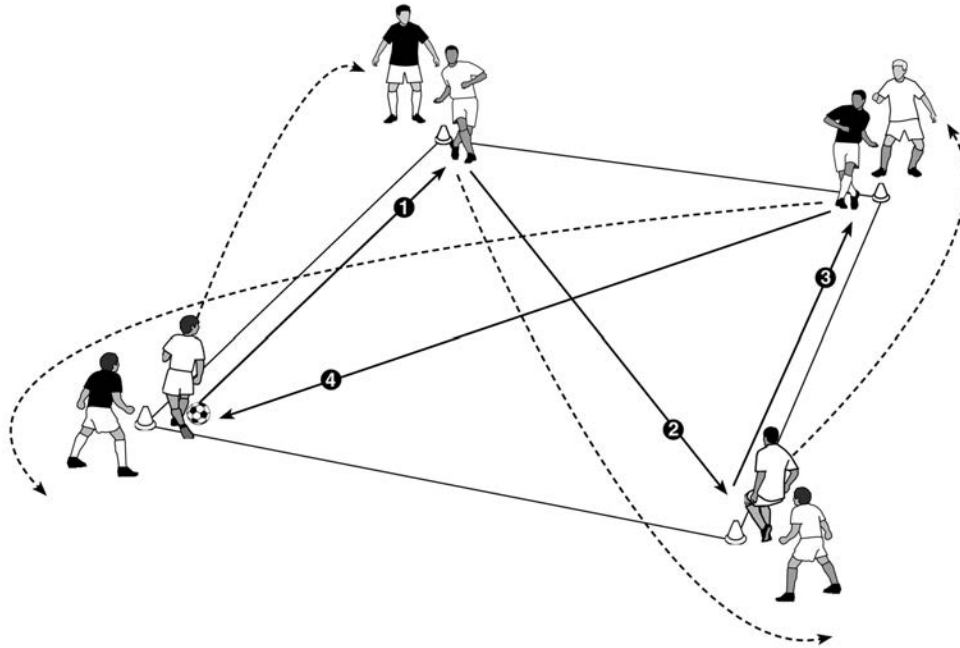

Figure 16-39

Players stand behind the cones on the corners of a 10-yard square grid. Player with the ball passes along the edge of the square and follows pass to back of line. Every pass along the edge of the square is followed by a pass and run across the square. This is shown in Figure 16-40. Coach should insist on quality passes and control in addition to player acceleration after the pass. For a variation, challenge players to complete a specified number of quality passes.

Figure 16-40



Let us begin in a square grid with three players as shown in Figure 16-42. The grid is sized to the ability of the players. A-1 passes to A-2 and begins run to opposite corner. A-2 passes first time to A-3 who delivers a long diagonal pass to overlapping A-1. A-1 can now make a square pass to A-3 running forward. The exercise can now be run in reverse with A-3 in possession first. As a variation, change the technique and delivery of pass- 3.

Figure 16-42

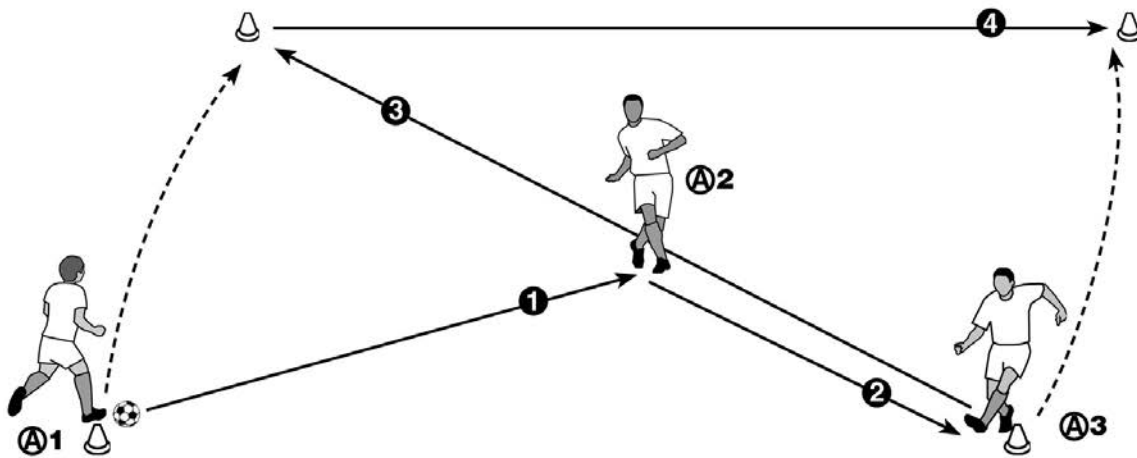

Now run the same drill and play to goal as shown in Figure 16-43 on page 81. The coach can add a defender, D-1, to mark A-1. Vary the defensive pressure to train player A-1. Now the coach can remove the cones and play free to goal. For variation, the coach can select the type of delivery A-3 makes to A-2, e.g., ball on ground, in air, one-touch, inside of foot, outside of foot, etc.

Figure 16-43

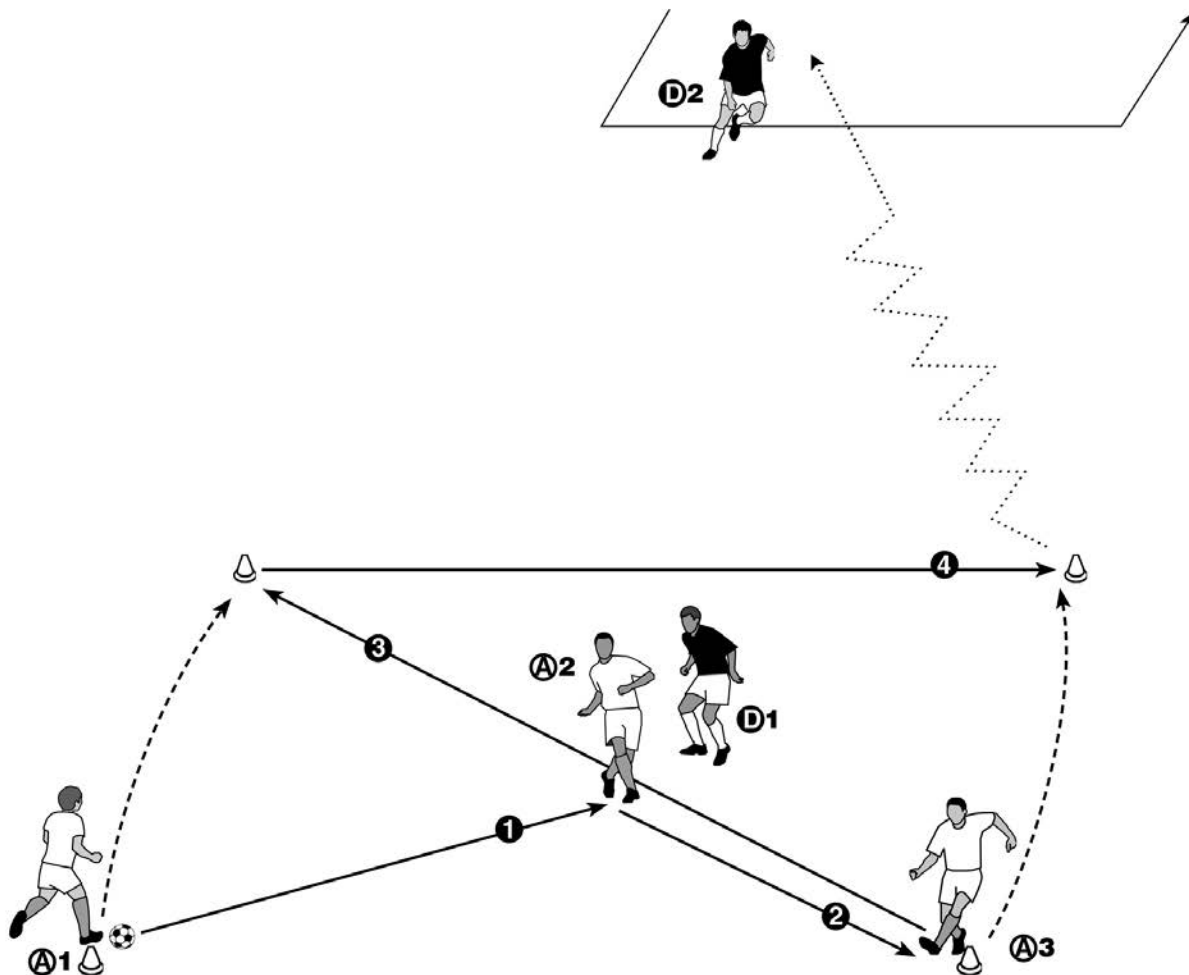

Restarts

The most common use of set plays occurs during restarts. The eight restarts are kick-off, throw-in, corner-kick, goal-kick, penalty-kick, direct free-kick, indirect free-kick, and drop ball. Since so many goals are scored from restarts, it is important to teach the attacking and defending principles relating to each of them. It is particularly important for the defense to be well schooled on restarts because the offense has the advantage of possession and determines the set play situation. Players must be aware of their own roles and the roles of their teammates. Being well organized on defense makes it much more difficult for the offense to succeed with their set play.

The attacking players should use movement and space to their advantage in completing the set play. Movement by the attacking players, particularly decoy runs, will help create the space needed to successfully complete the desired play. With the exception of the throw-in and drop ball, all restarts give an immediate advantage of space to the attacking team by requiring that the defending players remain ten yards from the ball until it is put into play.

Let's now take a look at each of the restarts individually.

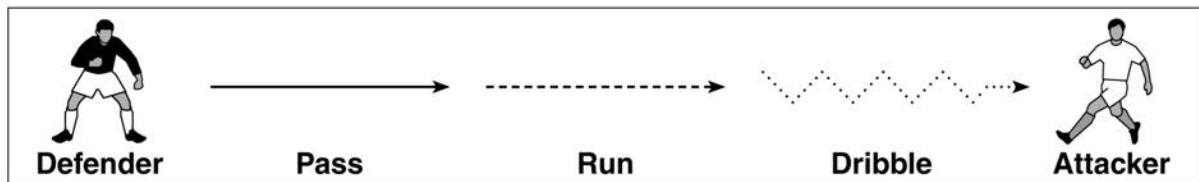

Kick-off

To start the game at the beginning of a half or after a goal has been scored, the attacking team must play the ball forward from the center spot a distance at least equal to the circumference of the ball. The player taking the kick-off may not touch the ball again until another player has touched it, and all defending players must be at least 10 yards from the ball (outside the center circle) until the ball has been played. It should be noted that a goal can be scored directly from a kick-off. Attacking players participating in the kick-off should be as close together as possible to obtain maximum use of the center circle.

The primary objectives of the attacking team is to retain possession and to allow time for penetration into the opponent's half of the field.

The primary objective of the defense is to apply immediate pressure to the ball, mark the players who have penetrated the defending half of the field, and to regain possession of the ball as quickly as possible.

An example of a kick-off is for an inside forward to kick-off to another inside forward who, in turn, passes back to a midfielder. This allows sufficient time for the forwards to penetrate the defense, and the midfielder can then pass to an open attacker as the play develops. Attackers should read weaknesses in the defense and make their runs according to those gaps. Kicking the ball as far up-field as possible on kick-off should be discouraged by the coach. Remember, the objective is to retain possession, and it makes no sense to give the ball away.

Throw-in

The most frequent restart in soccer is the throw-in. It occurs after the ball crosses the touch-line and is awarded to the team that did not touch the ball last. Many players and coaches treat the throw-in very casually and use it only as a way to get the ball back in play. This is especially true if the ball is in the middle of the field where the potential for attacking or the risk of being scored on seems remote. Throw-ins, however, should be viewed as a tactical weapon and an opportunity to start an attack. It is important to remember that the first player to receive the ball from a throw-in is exempt from offside, and the attacking team can take a penetrating position before the ball is thrown to them. On defense, the defenders must be careful not to be influenced into poor positions, which allow an attack on their goal.

To execute a proper throw-in, the player must face the field of play. Part of each foot shall be either on the touch-line or on the ground outside the touch-line. The thrower must use both hands and deliver the ball from behind and over the head in one continuous motion.

Some of the common errors include:

- Holding the ball incorrectly which does not allow the thrower to generate any power
- Lifting the rear foot while making the throw, particularly when using a run-and-throw technique.
- Not throwing the ball for ease of control by the receiver.
- When possible, the ball should be thrown to the receiver's feet.
- The players off the ball do not move and are easily marked out of the play.
- After the ball is released, the thrower does not immediately move into the play.

In order to develop motor skills for the throw-in, each player should individually practice the correct technique without the ball. This will assure that each player can perform the correct body movement. As a build-up, consider pairing off players and separating them by a distance appropriate for their age. Players should practice by performing throw-ins to their partners. Encourage your players to throw for easy control by their partners. Increase the distance between players as they become more proficient. Players should control or head the ball when receiving the throw-in. This relieves boredom and builds proficiency in more than one needed skill.

As a further build-up for throw-ins, consider training your players to execute a proper throw-in with a moving receiver. A typical beginning drill is shown below (Figure 17-1). Player A-2 receives the ball when player A-1 executes the throw. Separate the players about twice the distance as in the previous drill. Player A-2 sprints towards the thrower and at the halfway point turns, and runs parallel to the touch-line to receive the throw from A-1. For the first few throws, designate the direction A-2 will run. Then, allow A-2 to indicate direction through the use of simple hand signals. Next, require A-2 to employ a fake or feint before turning.

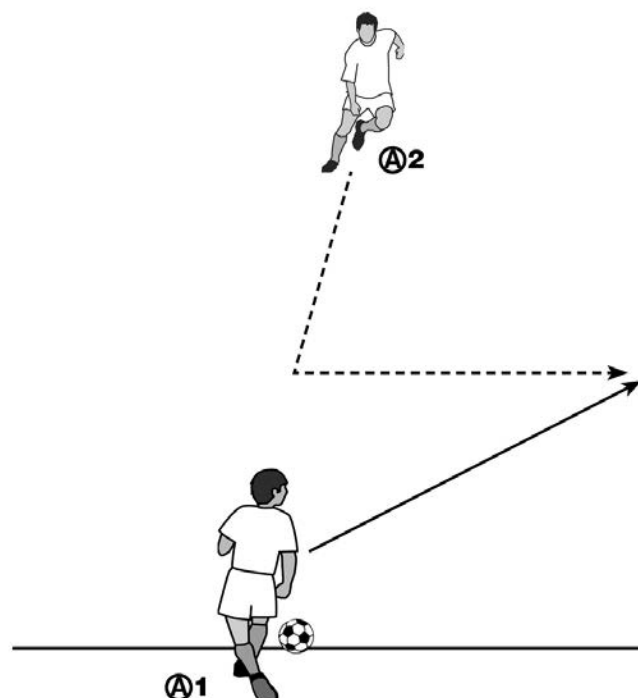

Figure 17-1

Make certain that your players understand the attacking and defending tactics of a throw-in:

Attacking Tactics

- Take the throw-in quickly to take advantage of defending players who lose concentration.
- Throw to an unmarked player when possible.
- Throw the ball forward, toward the attacking goal, to put more defending players on the wrong side of the ball.
- Throw the ball for easy control by the receiving player.
- Movement by receiving players is important to create space for the throw-in. Spread the defense so that support is difficult.

Defending Tactics

- Delay the action to set up defensively.
- Maintain defending concentration.
- Mark attacking players goal-side while ball is being retrieved.
- Mark open zones.
- Mark the thrower.
- Apply immediate pressure to the player with the ball.
- Remember that a player is not in an off-side position directly from a throw-in. Defenders usually do not take throw-ins in their defending third of the field. They may, however, when the throw-in can be quickly taken for the team's advantage.

Corner-kicks

A corner-kick is used to restart the game after the defending team has played the ball over their goal-line (not a goal), whether in the air or on the ground. It is taken by kicking the ball into play from the corner arc on the side of the field where the ball went out. The corner-kick should be considered an immediate scoring opportunity and is well suited to set plays. It is important to remember that a goal can be scored directly from a corner-kick. A player who receives a ball directly from a corner-kick cannot be judged off-side.

Defending Tactics

It is very important for the defense to react quickly when the referee calls for a corner-kick. Each player should be aware of the various defending assignments involved with this set play and should immediately move into the closest unfilled position. This will require good communication between the players to ensure that all vulnerable areas are covered. The defense should always attempt to have defenders in equal or greater numbers than attacking players. The safest way to defend is by having numerical superiority.

Current defending strategy calls for the goalkeeper to play midway between the goal-posts just inside the goal-line and facing the kicker. This allows for a balanced defense against attacks to the near or far posts. The keeper should take charge of the penalty-area with both his physical and verbal presence. A defender should also be quickly positioned near the goal-line ten yards from the ball to prevent a low crossing shot to the goal-area and to help defend against a short corner-kick. If a short corner-kick is evident, an additional defender should move toward the corner to assist.

There are several other key areas or zones which must be covered by defenders. Players should be positioned at the near and far posts with responsibility for the areas in front of them. An additional defender should be positioned in the area of the penalty-kick mark. These defenders should react to the flight of the ball and not to attacking players who move into or through their zone.

Other defenders that do not have a fixed position can be used to closely mark specific attacking players by standing between them and the goal (goal-side). The defenders should use their position and speed to beat the attackers to the ball and play it away from the danger area. Generally, clearing balls should be played high, wide, and far.

Attacking Tactics

When setting up the attack for the corner, a player should be positioned close to the goal and in front of the goalkeeper in order to challenge for balls played into the goal-box. As many other attacking players as possible should be included in the attack, however you must be prepared to deal with balls that are cleared by defenders back towards your own goal. Attackers can be deployed in various positions outside the eighteen-yard line and should make runs to strategic locations around the goal. The runs should not begin until the ball is kicked, and they should be timed so the player arrives at the correct position running full speed as the ball arrives. This will allow the player to gain increased height on air balls and will add velocity to the scoring attempt.

There are three strategic areas that must be played in as the players make their runs (Figure 17-3). One attacker must move to an area just outside the near post. This player has the option of shooting on goal by kicking or heading, letting the ball pass by untouched to another attacker or heading the ball to another player, usually near the far post. The second strategic area to attack is the area just outside of the far post. The player in this area should be looking for balls kicked long, balls being passed back, or balls allowed to pass through by the teammate on the front post. The third strategic area is around the penalty-kick mark. This player should look primarily for partially cleared balls. The rest of the attackers should move to various positions near the goal in staggered runs from outside the penalty-area. By beginning their runs at different times and coming from different directions, they can create confusion in the defense.

Short Corner-kick

A short corner kick is an effective tactic when it can be taken quickly before the defense can mark the corner (Figure 17-2). The player receiving the corner-kick should move to a position on the goal line so that when the ball is received, the rest of the team will be on-side and ready to participate in the play. If the corner is marked by a defending player, the player receiving the short corner should be closer than ten yards from the corner arc to take advantage of the ten-yard zone. This permits time for the kicker to move onto the field into a support position. The ball can then be dribbled, passed, or shot on goal. If the defense has packed the penalty area with players, the short corner can be used to draw the defenders toward the ball and then chipped behind them to initiate an attack. The short corner kick can also be used when a small forward line finds it difficult to win possession of an air ball or where the player taking the kick cannot reach the center of the goal for physical reasons or due to playing conditions such as high winds or muddy field. The attacking runs should not begin until the ball is kicked in the direction of the goal or they will reach the target area prior to the ball.

Figure 17-2

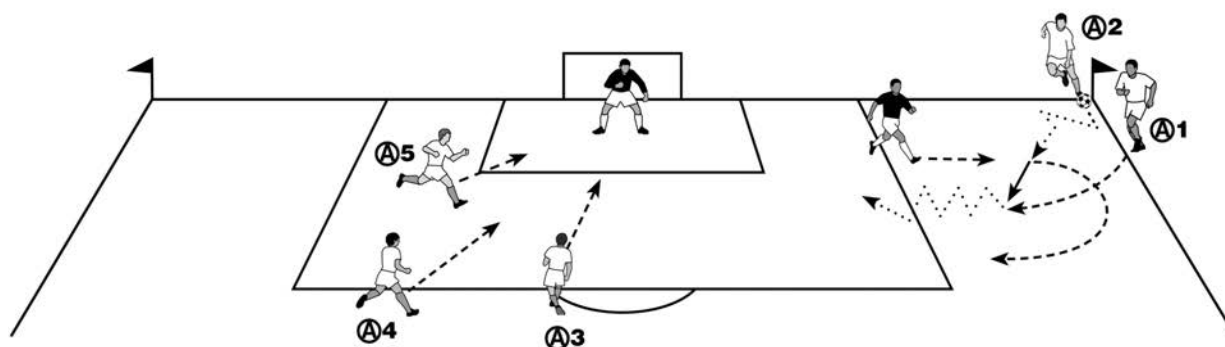

Short Pass Corner-kick

The short pass corner-kick is very similar to the short corner-kick and is an attempt to create the impression that a long corner-kick is going to be taken (Figure 17-3). This is usually a set play and is intended to catch the opposition by surprise. As the kicker approaches the ball to take the corner-kick, a teammate, usually a midfielder, breaks toward the corner to receive the kick. The kicker then immediately moves into an on-side position to support the player with the ball. The receiver then has the option to shoot on goal, pass or dribble to a more advantageous position. As with the short corner-kick, the other attackers should not begin their runs until the receiver shoots or crosses the ball toward the goal. This again will allow the attackers to arrive at the correct area at full speed.

Figure 17-3

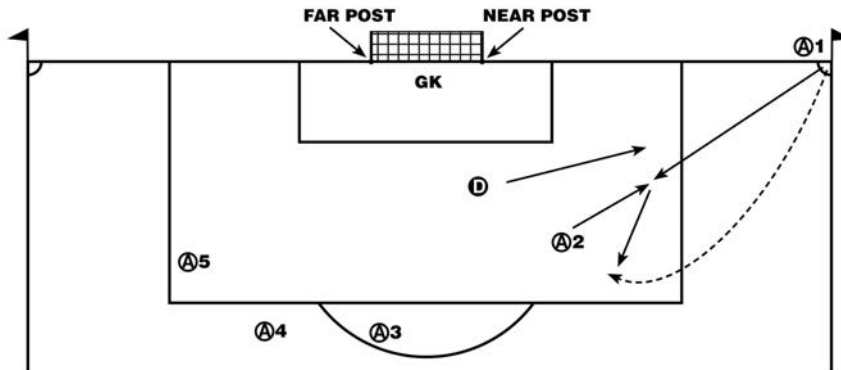

Long Corner-kick

The long corner-kick is a direct attack on the goal and is responsible for a high percentage of goals scored. There are two types of long corners that are possible, the in-swing and the out-swing. Many young players have problems delivering either an in-swinging, or out-swinging corner. A major key is the angle of approach, and obviously the use of the correct leg. Coaches must demonstrate this carefully.

When setting up for the long corner, one attacker should be positioned near the goalkeeper in the goalarea. It is very important that this player be aware of the defenders to ensure an on-side position after the ball is played (Figure 17-4).

The ball should be directly kicked into one of the three strategic areas previously mentioned where it can be played by one of the attackers moving into position from outside the eighteen-yard line. It is beneficial to have your taller players moving to the areas at the near post and in front of the goal to challenge for air balls by heading.

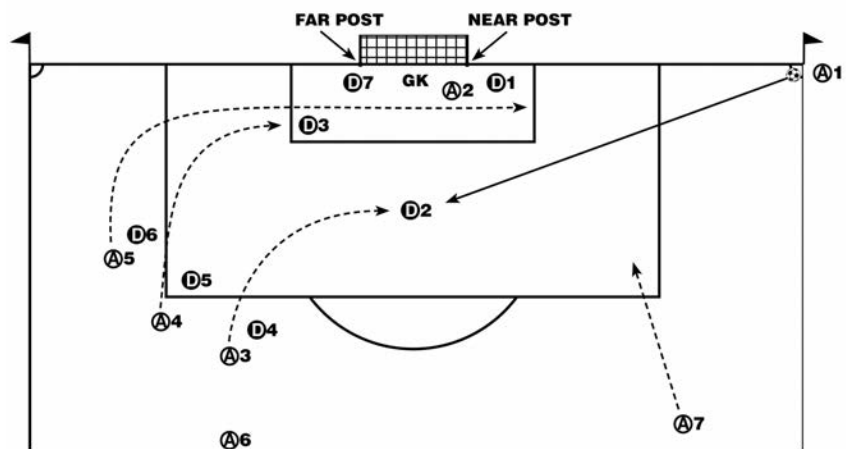

Figure 17-4

Build-up

The build-up for the short corner-kick and the short-pass corner-kick should begin with play that revolves near the corner. Begin with four players. For the short corner-kick, position two attackers at the corner and a threatening defender and goalkeeper (Figure 17-5). Let the kicker tap the ball along the goal-line to the receiving player. Allow the defender, positioned ten yards away, to apply light pressure. The receiving player should try to draw the defender. Once the defender has committed, a pass should be made to the kicker who has moved into a support position. This player can then advance the ball toward the goal where a shot can be taken. The four players can be rotated to allow each player to work in the corner.

The defender should vary play to avoid constant commitment to A-2. This allows A-2 to advance the ball on goal. Once the play near the corner has been developed, you can introduce more attackers and defenders

Figure 17-5

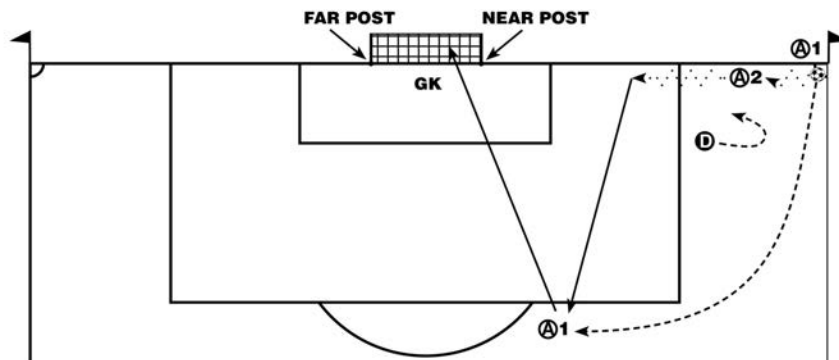

The build-up for the short pass corner-kick is similar to the short corner-kick. Begin with four players positioned as shown in Figure 17-6. The marking defender, D-1, should only apply light pressure until the tactics are understood. As player A-1 approaches the ball, player A-2 breaks toward the corner to receive a pass. The defender should follow, applying light marking. Player A-2 can then turn with the ball, advance toward goal, and shoot or pass when challenged by the defender. Player A-1 must be careful not to move into an off-side position.

The build-up for the long corner begins with three players, two attackers (a kicker and a receiver) and one goalkeeper. The kicker should play the ball into one of the strategic areas where the receiver will play the ball. The goalkeeper should only play balls that are poorly kicked, such as into the goal (six-yard) box. The kicker should be changed frequently to avoid becoming too tired. You can continue to build this up by adding attackers until the situation resembles an actual corner-kick. Gradually introduce defenders until you have an even number of defenders and attackers.

Figure 17-6

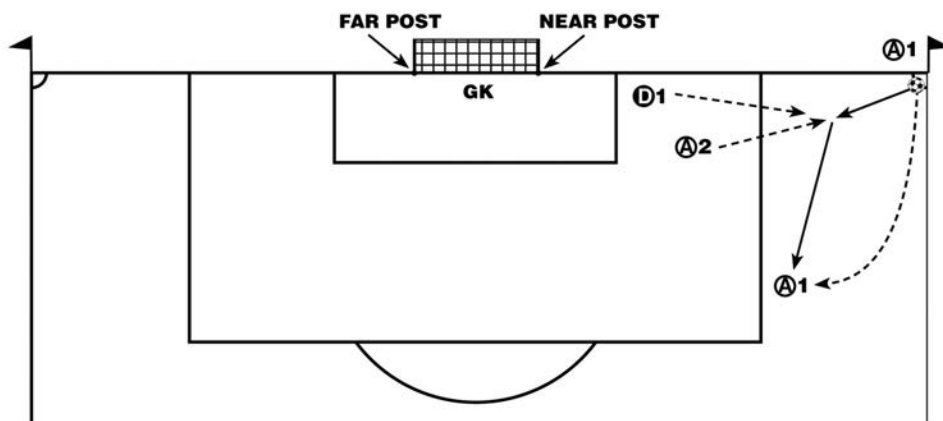

Goal-kick

A goal-kick is used to restart the game if the ball crosses the goal-line without entering the goal and the attacking team last touched the ball. The ball may be placed anywhere within the goal area. The team taking the goal-kick attempts to maintain possession while simultaneously gaining field advantage.

Attacking Tactics

The most common goal-kick is the long goal-kick that plays the ball as far up-field as possible. The object of the long ball is to play the ball into the opponents' half of the field and increase the chances for an attack. One of the disadvantages of this kick is the 50-50 opportunity to maintain possession. When making a long goal-kick, the kicker should use an instep drive. Especially in the lower age divisions, the ball should be played to the wings to prevent a direct shot on goal if possession is lost. In the older age groups, it is possible to play the ball in the middle since the ball will be played farther up-field. Players from the attacking team should look for open areas of the field to become targets to receive the ball. The player receiving the ball should be quick to move to the ball, and teammates should move to supporting positions.

A variation of the short goal-kick is to play the ball out to a teammate who is unmarked and who can then begin the attack from the defending half of the field.

Defending Tactics

Each of the defending players should have a specific assignment on goal-kicks. Although the Laws permit it, tactically it is not a good idea to have defenders within the goal-area. Each attacker should be kept in view and marked by a defender. It is important to mark the attackers closely but not so tightly that the player can move off into open space. The defender also must be careful not to give the attacker too much space to operate in. After the goal-kick has been taken, the defender should move to the ball and attempt to control it. If the defender is unable to control the ball, then pressure should be applied to minimize the options of the opposing player receiving the ball.

Dropped Ball

A dropped ball is used to restart the game after a necessary stoppage by the referee. It is important to remember that a goal may be scored directly from a drop ball.

Tactics

The referee will usually call two players together, one from each team. The ball is dropped, not bounced, between the players and cannot be touched by either player until it hits the ground. After touching the ground, the ball is deemed in play. If the drop ball occurs near the goal, defending players should be positioned to clear the ball and remove the threat of attack. Likewise, attacking players should be prepared to support the dropped ball and shoot on goal.

Free-kicks

A free-kick is awarded for either a penal or non-penal foul and other technical infractions. The free-kick is used to put the ball into play by shooting or passing to a teammate. A penal foul results in a direct free-kick from the spot of the foul, and a goal may be scored directly from that kick. If the defense commits a penal foul in their own penalty-area, a penalty-kick is awarded to the attacking team. Non-penal fouls result in the awarding of an indirect free-kick. An indirect free-kick must touch another player from either team before a goal can be scored.

The greatest concern by the defense should be for those free-kicks that are awarded near the penalty area. This is where the attacking team can most effectively attack the goal. In most cases a wall should be used to defend in this situation. In order for players to distinguish between a direct and indirect free kick, the Laws require the referee to raise his hand for an indirect kick and to keep it raised until the ball is played by a second player.

The Wall

Defending Tactics

As soon as a free-kick is awarded near enough to the goal to present an immediate threat (this will vary with the age and skill level of the players), the defending team should begin setting up a wall between the ball and the goal. This is very important so that the attackers do not get an unobstructed shot on goal. FIFA Laws require the defenders to be ten yards from the ball, however, some teams will line up closer to give the defense time to finish setting up. This is against the rules and, at the referee's discretion, a yellow card could be given. The goalkeeper is responsible for determining how many players are needed in the wall to best defend the situation. The closer to the goal and the center of the field, the more defenders required to be in the wall. The goalkeeper should move to the near post and direct the end person in the wall so that the near post is sufficiently protected, then move to a position halfway between the remaining vulnerable area (between the far post and the nearest point in the wall). The players in the wall line up next to one another, shoulder to shoulder, with their hands positioned for protection. They should attempt to keep opponents out of their wall to prevent shots made through the wall and away from the goalkeeper.

One technique you may consider is to number your defending players, or those players likely to be nearby, if a wall is needed. In that way, the goalkeeper can simply state the number of players to be in the wall, and the correct players can immediately move into position. For obvious reasons, the players you choose to be in the wall must have a fair amount of courage to defend the kick. The remaining defenders should be positioned to defend a specific area around the wall or mark up man to man. They should be careful, though, not to be closer to the end line than the wall so the attackers have to be concerned about being off-side. The nearest defender not in the wall should be responsible to directly attack the ball.

Attacking Tactics

Probably the most important thing to remember when attacking is to try to take the kick quickly before the defense has time to set up the wall. If the wall is already set, be sure that all the attacking players understand their responsibilities. There are any number of set plays which you can run to attack the wall. One technique which can be used, especially early in the game, is to try to force a shot directly through the wall. Even if unsuccessful, the defenders may be less courageous on plays later in the game. If you try this play, be sure to use a player who has a strong shot. You might also try to put one of your attacking players in the wall to disrupt it or to give your kicker a place to kick through the wall.

Other effective techniques involve plays designed to go around or over the wall. This could be a chip shot over the heads of the defenders in the wall or a pass to a teammate making a run to a predetermined position. Be sure to use decoy runs if you choose this option.

Direct Kicks

Direct kicks are awarded when a penal-foul is committed. The kick is indicated by the referee blowing the whistle and pointing toward the goal of the offending team.

Attacking Tactics

The kick should be taken as quickly as possible to prevent the defense from getting set up. Your players should remember that a signal from the referee is not necessary to begin play. Plays should be fairly simple and easy to execute quickly. If the defense is able to set up, be sure that all of the attacking players know their assignments. If the kick is taken on goal, it should be followed up in case of rebounds. Additional players should be brought forward to participate in the play and increase the pressure on the defense. Be sure, however, to leave at least one defender at midfield to clear any balls played back towards your half of the field.

Defending Tactics

If the kick is to be taken close enough to shoot on goal, a wall should be formed. If not, defenders and midfielders should quickly move goal-side of the ball and try to get numerical superiority. Attacking players should be closely marked and the defense must be alert to a quick kick. The nearest defender to the ball must challenge the kick as soon as the ball has moved. The goalkeeper should be positioned with a view of the ball. After the kick is cleared, the defense should push the ball forward as long as it maintains possession.

Penalty-kicks

When a defender commits a penal-foul in the defender's own penalty-area, a penalty-kick is awarded to the attacking team. In theory, every penalty-kick should result in a goal being scored. The ball is placed on the penalty-kick mark, centrally located 12 yards in front of the goal. All players must be outside the penalty-area and 10 yards from the ball and at least 12 yards from the goal-line, with the exception of the goalkeeper and the shooter. The ball cannot be played until the referee blows the whistle.

Attacking Tactics

The shooter should place the ball firmly on the penalty-kick mark so it will not move prior to the kick and should tee it up as much as possible to make the kick easier. Be aware of balls that are placed in a hole at the penalty-kick mark and reposition the ball if necessary. The shooter should approach the ball from directly behind it, not at an angle, and strike the ball with an instep drive or a firm push pass. Accuracy is much more important than power, and the ball should be placed low and just inside one of the posts for maximum effectiveness. The shooter should decide in advance the placement of the shot and not deviate. If the ball is shot accurately it will be nearly impossible to stop. Care should also be taken not to give away the direction of the shot prior to it being taken. The other teammates, forwards and midfielders, should be positioned around the penalty-area and be alert to missed shots that may rebound off the goal or goalkeeper. Remember, if the ball rebounds off the goal, it must be touched by another player from either team before the shooter can play the ball again.

A coaching point to consider is to not allow the player that has just been fouled to take the penalty kick. That player may be in a highly emotional state and a player that was not involved in the foul may be better able to make a controlled shot. Also, the best penalty-kick shooter is usually the most accurate shooter, not necessarily the most powerful. This is a great opportunity to score; use it to your advantage.

Defending Tactics

The goalkeeper must be positioned with a part of both feet on the goal-line between the goal-posts and is not permitted to move his or her feet off the goal-line until the ball is struck by the shooter. The goalkeeper may play anywhere on the goal-line and is not limited to the midpoint between the posts. As the ball is about to be struck, the goalkeeper should make an informed guess as to the direction of the kick and move or dive in that direction to attempt a save. The goalkeeper should look at the direction of the shooter's approach, the plant foot and the shooter's body movement. The rest of the defenders should be positioned around the penalty-area with several attempting to locate at the point nearest the ball on both ends of the penalty-arc. They should be alert to rebounds and should move to the ball as soon as it is struck by the shooter in order to clear it from the goal-area. It is important that defenders be positioned on both sides of the penalty-area to cover all angles of deflection.

Indirect Kicks

Indirect kicks are given when non-penal fouls are committed. They are taken from the point of the infraction and may be taken immediately. In order for a goal to be scored, the ball must touch a second player before going into the goal.



Attacking Tactics

As with direct kicks, the attacking team should try to play the ball quickly before the defense is set. The most common way to play an indirect kick is to have one player make a very short pass to a teammate who can then shoot directly on goal. The players must be careful not to try too long a pass which allows the defense to close in before the shot on goal can be taken. Other strategies that apply to direct kicks can be used for indirect kicks as well.

Defending Tactics

The defending tactics for indirect kicks are the same as direct kicks except special consideration must be given to the short pass being made by the attackers. Immediate pressure should be put on the player receiving the pass and attempting to take the shot on goal.



Goalkeeping

The goalkeeper occupies a unique position on the soccer field - the demands are unique; the pressure to perform perfectly each time is intense; and the skills and preparation required to do so are very special.

Role

Goalkeepers are the only players who can use their hands, and their responsibility is preventing goals. But that important objective is only part of the goalkeeper's role. The goalkeeper has three very important responsibilities:

- Stop shots/crosses to prevent goals.
- Support defense.
- Initiate/participate in attack.

It is very important to insure that the goalkeeper understands well the specific aspects of the Laws regarding goalkeepers. Lack of knowledge in this area can result in excellent goal scoring opportunities for the opposing team.

Requirements

Fitness

Flexibility, agility, strength, power, endurance, quickness, and coordination of movement are key physical characteristics.

Psychological Make-up

More than any other position on the field, the goalkeeper must be strong psychologically. This includes being confident, courageous, and accepting responsibility.

Technique

While natural ability is important to this position, catching, punching, deflecting, and diving require specific techniques. Only through coaching and practice can the goalkeeper gain maximum performance in each situation.

Tactical Understanding

To anticipate the opponent and make correct decisions when initiating the attack, the goalkeeper must be trained on tactics. This becomes more important in the older age groups.

Technique

Basic Position

The basic position for the goalkeeper is eyes on the ball, feet shoulder width apart, trunk bent slightly forward from hips, forearms almost parallel to ground, and elbows bent with hands slightly cupped



and pointing slightly upward. Knees are bent for power and feet are pointing in the direction of the ball.

Collecting Position

Body behind ball, waist bent, feet slightly apart, palms stretched outward to roll ball up into chest. More difficult balls may require dropping on one knee - perpendicular to path of ball and rolling ball up into body.

Catching Positions

Basics rules for catching include: hand positioned in a “W” or “butterfly,” thumbs behind ball, body behind ball, catch on fly (not on bounce) if possible, and guide catch into body.

Catch at waist

Control ball by bending trunk, keeping elbows in, palms up, and rolling ball from palms to body to absorb shock.

Catch at chest

Palms downward and elbows slightly in front of chest.

Catch at/above head

No margin of error, make sure hands are properly placed, concentrate on strength to hands, keep forearms parallel, and bring ball into body as quickly as possible.

Punching

When in doubt, punch out! Punching is used when a ball is uncatchable due to speed, pressure, or risk.

- Clench fists to make flat surface.
- Use two fists.
- Hit ball slightly below center.
- Never punch across mouth of goal.
- Direct your punch to start attack.
- Moving forward, punch forward and vice versa.
- Deflect with open palm if necessary.

Diving

Diving is a lateral movement by goalkeepers to contact the ball when there isn't time to move the ball any other way.

- When diving left, land on left side.
- When diving right, land on right side.
- Plant rear foot in direction of ball.
- Bend and push off the near leg for distance.
- Lift far leg across for height.
- Extend arms to catch, punch, or deflect ball.
- Use ball to help absorb fall.
- Pull ball into body after you hit the ground.
- Arc body down as you fall.
- Bring legs up and tuck ball safely away.
- Rotate hip and don't plant near leg for low shots.
- Push off with far leg for distance on low shots.



Distribution

The goalkeeper starts the attack by putting the ball back into play. Accuracy and maintaining possession are the prime objectives. Distance is secondary.

Throws

- Underhand roll – “bowling” - quick, short, accurate. Should not bounce.
- Overhand – “baseball” - longer distance, arrives quickly after one or two bounces.
- Overhand – “arc/sling” - most distance, less accuracy, may take too much time, allowing for interception.

Kicks

- Volley – “punt” - greatest distance, not too accurate, can relieve pressure or create numerical advantage.
- Half-volley – played low to give accuracy and less distance.
- Right foot kick – serve ball with left hand. Practice kicking into goal to save ball chasing.

Positioning

Angles

- The only time the goalkeeper’s feet should be on the goal-line is during a penalty kick. FIFA Law 14 requires the goalkeeper to have a part of each foot in contact with the goal-line until the penalty-kick is taken.
- Other times the goalkeeper should use angle play to improve the chances of making a save. Angle play means reducing uncovered goal-area available to the shooter by moving toward the shooter.
- The basic rule of angle play is to draw an imaginary line from each goal post to shooter, forming a triangle. Move out from goal-line thus reducing size of triangle (i.e., creates two triangles of smaller size, one on each side of goalkeeper).
- Always protect the near post, so move forward favoring the near post until you can touch both imaginary lines from shooter to each goal-post.
- If not timed properly, coming out will expose the goal to a chip or loft shot.

Defenders

Goalkeepers should position themselves to utilize defenders as blockers of part of mouth of the goal.

Break-away

- Objective of a goalkeeper is to get to the ball before the attacker shoots. A goalkeeper must be decisive - once committed, go for it - by moving out on the proper angle, covering the goal with a parallel dive, and having the hands toward the near post.
- Encourage the goalkeeper to play up between the goal and penalty-line when the ball is in the opponents’ half of the field, moving back as necessary.

Skills Build-up

Fitness

- Goalkeepers require more warm-up than other field players. Warm-up should stress flexibility through stretching and agility exercises.
- Make certain your goalkeepers do exercises with a ball - either in hand or close to body.

Catching (Static/Dynamic)

- Easy rolls straight to goalkeeper; increase speed. Slight bouncing rolls. Easy rolls to either side; increase speed. Slight bouncing rolls; increase distance to sides.
- Easy throws waist high; harder throws. Bounces to waist high. Close in easy kicks to waist high; faster kicks. Shots to waist. Add static defenders. Add dynamic defenders. Goalkeeper facing goal, turns on command to save ball rolls then waist high. Goalkeeper facing forward does forward roll, then saves appropriately. Add static and dynamic defenders.
- Same as (2) above for over head. Work in pairs. Throw first, then kick. Include crosses.

Diving (Static/Dynamic)

- Goalkeeper sitting, legs stretched forward falls to side to retrieve ball. Change sides, speed, and bounce.
- Goalkeeper now on knees. Same as (1) above.
- Goalkeeper standing facing coach or partner who is holding ball at waist level, dives and take ball away. Change sides and height. Goalkeeper turns on command to take held ball.
- Repeat (3) above with thrown ball.
- Repeat (3) above with kicked ball.
- Goalkeeper standing as in (3) above, but add obstacle on side, i.e., cone, equipment bag, bench, kneeling player.
- Add static and dynamic defenders to all drills above.

Throwing/Kicking (Static/Dynamic)

- Static throwing, practice accuracy, add distance.
- Throwing from "save," add distance.
- Add target player to (2) above.
- Add static and dynamic defenders to all above drills.
- Repeat all drills for kicking.

Angles (Static/Dynamic)

Walk goalkeeper through angles using ropes and static shooter. Roll ball, throw ball, shoot. Let goalkeeper see angles by switching places with shooter.

Break-away (Static/Dynamic)

- Have goalkeeper spring out of goal on command to static ball. Roll ball toward goal, increase speed.
- Add attacker.
- Try chip and loft shots to complicate.
- Practice dive at first from static positioning for safety to motion without shot and finally shot attempt.

Coaching Hints

- Goalkeeper should direct defenders.
- Insist older players listen to goalkeeper on commands to mark, cover, pass back, etc.
- Provide goalkeeper with set distribution objectives for younger players.
- Teach players and goalkeeper how to pass back without violating the Laws.
- If goalkeeper takes goal-kick, one fullback goes into mouth of goal in younger divisions.
- Rotate younger goalkeepers. Always have two or three in reserve.
- Involve goalkeeper in all field drills, as well as goalkeeper drills.



Glossary of Soccer Terms

Ballistic: stretching with movement

Center: to pass the ball from the side of the field into the middle of the field

Charge: legally upsetting an opponent's balance by shoulder-to-shoulder contact

Clear: a throw or kick by the goalkeeper or a kick by the defender in an attempt to get the ball away (clear) from the goal area

Combination play: passing combinations executed by two or more players. The most common example is the wall pass

Cross: center

Defender: primarily a defensive player who assists the goalkeeper in protecting the goal area

Dribble: a way of advancing the ball by a series of short taps with one or both feet

Dynamic: moving

Far post: side of the goal or goal post farthest from the ball

Forward: primarily an attacking player

Goalkeeper: the last line of defense. The goalkeeper is the only player who can use his hands within the field of play. Use of hands is limited to within the penalty area

Grid: a marked, restricted playing area.

Halfback: another name for midfielder

Half-volley: kicking the ball just as it is rebounding off the ground

Hands: illegal act of intentionally touching the ball with the hands or arms

Heading: a method of scoring, passing, and controlling the ball by making contact with the head

Linkman: another name for midfielder

Lob: a high, soft kick which lifts the ball over the heads of the opponents

Marking: guarding an opponent

Midfielder: a player who is primarily responsible for moving the ball from the defenders to the forwards

Near post: side of the goal or goal post closest to the ball

Obstructing: preventing the opponent from going around a player by standing in the path of movement



One-touch pass: a pass made without controlling it first

Overlap: the attacking play of a defender or midfielder going down the touch-line past his or her own winger

Pitch: another name for the field of play

Pressure: action of a defender to restrict time and space available to the offensive player

Save: goalkeeper stops an attempted goal by catching or deflecting the ball away from the goal

Screen: retaining possession and protecting the ball by keeping your body between the ball and opponent

Set play: a planned offensive movement to be executed at a free kick
Shielding: see Screen

Sliding tackle: attempting to take the ball away from the opponent by sliding on the ground and using the feet or legs to block and hold the ball

Static: stretching against muscle and holding as opposed to bouncing

Striker: a central forward position with a major responsibility for scoring goals

Sweeper: a defender who roams either in front of or behind the defensive line to pick up stray passes

Tackling: attempting to or taking the ball away from an opponent when both players are playing the ball with their feet

Takeover: a 2 vs. 1 combination play in which the two offensive players move toward each other and the ball is transferred from one player to the other

Through pass: a pass that goes between two players and behind the defense

Control: controlling a ball by means of the feet, thighs, or chest

Two-touch pass: a passing technique in which one touch is used to control the ball and the second touch is used to pass the ball

Volley: kicking the ball while it is in flight

Wall pass: a pass to a teammate, followed by a return pass on the other side of the opponent, also called "give-and-go."

Wing: an area of the field near the touch-line

Winger: name given to the right and left outside forwards



Appendix A: Laws of the Game

Essential Facts for AYSO Coaches

Welcome to the family of AYSO coaches. Your volunteer participation is greatly appreciated. The AYSO National Coaching Commission in cooperation with the National Referee Commission has prepared this information to assist coaches in learning and understanding the Laws of the Game. As your coaching experience increases, so will your need for additional instruction. Our courses are designed to support those needs as they arise. You should obtain a copy of "Guidance for Referees and Coaches" to supplement your training and understanding of AYSO policies and interpretations of the Laws. Additionally, you should obtain a copy of "Short-Sided Games Guide for Referees" to become familiar with differences in Law application in the various younger age groups playing short-sided games.

AYSO is an affiliate member of the United States Soccer Federation (USSF) the national governing body of soccer in the United States recognized by FIFA (Federation Internationale de Football Association), the international governing body of soccer. All AYSO matches are played in accordance with the FIFA Laws of the Game and the AYSO National Rules and Regulations. Since FIFA meets annually to consider changes to the Laws and AYSO considers proposed changes to its National Rules and Regulations each year at the AYSO Annual General Meeting, it is strongly recommended that each year you obtain the current AYSO edition of the FIFA Laws of the Game and the AYSO National Rules and Regulations to familiarize yourself with the most recent changes.

As you gain knowledge and experience as an AYSO coach you will find that your understanding of the Laws of the Game and of the job of the officials will increase. To truly understand officiating, we recommend strongly that you "walk a mile in his shoes". That is, try your hand at actually refereeing some matches. Experience as a referee can only improve your skills as a coach and is well worth the effort. Thank you again for volunteering your time and talents.

LAW 1: The Field of Play

Essential Facts about the Field of Play:

- Regular season play: Goal dimensions and field size at discretion of the region.
- Post-season play-off games: The field must conform to all requirements of Law 1.
- A coaches' area shall be marked, where possible, ten (10) yards on either side of the halfway line, and at least one yard from the touch line.
- Touch lines: Define sides of the field.
- Goal lines: Define ends of the field.
- Goals: 8 feet high and 8 yards wide.
- Halfway line: Divides field in half and belongs to both halves.
- Center mark: Location for kick-off.
- Center circle: 10-yard radius from center mark.



- Penalty area: Area in which goalkeeper may use his hands and where certain fouls result in a penalty kick.
- Penalty mark: 9-inch spot 12 yards from goal line indicates location for penalty kick.
- Penalty arc: 10-yard radius from penalty mark.
- Goal area: Defines location for goal kicks.
- Corner area: 1-yard arc defines location for corner kicks.
- Corner flag: Locates corner of field. May not be moved or removed during corner kicks.
- Optional equipment: Goal nets, halfway flags (1 yard outside touch line).

LAW 2: The Ball

Essential Facts Regarding the Ball:

- The referee approves the game ball.
- Ball cannot be replaced without the referee's permission.
- The size used in AYSO matches is regulated according to age division.

LAW 3: The Number of Players

Essential Facts Regarding Number of Players:

- 11 a side is the norm. 3 a side, 5 a side, 7 a side, and 9 a side are the AYSO recommendations for U-6, U-8, U-10, and U-12 respectively.
- A player who has been sent off may not be replaced.
- Substitutes come under the jurisdiction of the referee.
- One player on each team must be designated as the goalkeeper.
- Field players may change places with their goalkeeper at any normal stoppage in play. The referee must be notified that the change is taking place.
- In AYSO, each team member must play a minimum of one half of the match.
- Play may be stopped at any time by the referee to attend to an injured player. An injured player may be replaced or the team may play short while the injured player recovers. Only the injured player receives credit for playing that quarter. A dropped ball is used to restart play, if the ball was in play at the time of the stoppage.

LAW 4: The Players' Equipment

Essential Facts Regarding Players' Equipment:

- Jersey, shorts, footwear, and shinguards covered by stockings are required. Sleeveless jerseys are permitted as are rolled or tied up sleeves provided, in the opinion of the referee, it is done in a safe manner.
- Shinguards are required in all practices and games.
- The goalkeepers must be distinguishable from all other players on the field.
- Players may not wear anything that could endanger either themselves or another player.
- Casts or splints, jewelry, watches and articles of adornment are not allowed.

LAW 5: The Referee

Essential Facts Regarding the Referee:

- Should interfere with the game as little as possible, penalize only deliberate breaches of the Law, and not whistle for trifling or doubtful offenses.
- Authority includes all pre-match, half-time and post-match activities.
- May refrain from penalizing if it is to the advantage of the team against which the offense was committed.
- Is the official record and time keeper, and may add any time lost through accident or other cause.
- May stop the match and suspend or terminate play for any reason deemed necessary such as: the elements, interference by spectators, or other cause.
- Shall submit a detailed report of any misconduct.
- Allows no person other than the players and assistant referees to enter the field of play without permission.
- May stop the match to have an injured player attended.

LAW 6: The Assistant Referees

Essential Facts Regarding the Assistant Referees:

- Indicate when the ball is out of play.
- Indicate which side is entitled to a goal kick, corner kick or throw-in.
- Indicate when a player may be penalized for being in an offside position.
- Indicate when a substitution is requested.
- Assist the referee in the control of the match in accordance with the Laws.
- May signal any misconduct, incident, or breach of the Laws which occurred out of view of the referee
- Assistant referees' decisions may be overruled by the referee.
- Referee decisions may not be overruled by an assistant referee.
- Referees may consult with and accept the decision of neutral assistant referees to determine whether or not a legal goal was scored.

LAW 7: The Duration of The Match

Essential Facts Regarding the Duration of the Game:

- The match is divided into two equal periods (halves) which varies with age group.
- The teams will defend each goal for one period (half).
- Players have a right to an interval at half-time, which, in AYSO, shall be a minimum of five and maximum of ten minutes.
- Allowance shall be made, at the discretion of the referee, for time lost due to injury, substitution, time wasting or other cause.
- Time shall be extended to permit a penalty kick to be taken at or after the expiration of the normal time period.



- The referee is the sole time keeper for the match.
- If the referee terminates a match for any reason, the referee submits a game report to the governing body (Region) who will determine whether or not the game will be replayed, if the score will stand, or if a team shall be declared in forfeit. In AYSO, the referee submits a game report to the governing body (Region) who will determines whether or not the game will be replayed, if the score will stand, or if a team shall be declared in forfeit.

LAW 8: The Start and Restart of Play

Essential Facts Regarding the Start of Play:

- Play is started with a kick-off from the center mark
 - at the beginning of the match.
 - at the beginning of the second half – following a goal.
 - at the beginning of overtime periods.
- Play is restarted with a dropped ball where the ball was when the play was stopped while the ball was in play:
 - following an injury where no foul occurred.
 - for outside interference.
 - for needed repairs to the ball or field equipment.
 - for any cause not mentioned in the Laws.
- The team winning the coin toss chooses which goal it will attack in the first half. The other team must kick off. The team winning the coin toss takes the kick-off to start the second half.
- The ball is in play from a kick-off once it has been kicked and moves forward.
- Every player must remain in his own half of the field, and players of the team not taking the kick-off must remain at least ten yards from the ball until the ball is in play.
- The player taking the kick-off shall not touch the ball a second time until it is has been touched by another player. The penalty for this “double touch” is an indirect free kick.
- A goal may be scored directly from a kick-off.
- The kick-off shall be retaken for any infringement of the kick-off procedure.
- The dropped ball is in play once it has touched the ground.
- The dropped ball is retaken if it is touched by any player before it has touched the ground or if it goes out of play without being touched by a player.

LAW 9: The Ball In and Out of Play

Essential Facts Regarding Ball In and Out of Play:

- The ball remains in play until the entire ball has crossed the outside edge of either the goal line or touch line either on the ground or in the air.
- It is the position of the ball and not the player playing the ball which determines whether or not the ball is out of play.
- The ball is out of play when the referee has stopped play.
- The referee may also signal the ball out of play.



LAW 10: The Method Of Scoring

Essential Facts Regarding Method of Scoring:

- The ball must completely cross the goal line between the goalposts and under the crossbar for a goal to be scored.
- Only the referee may award or disallow a goal.
- The referee may accept the opinion of a neutral assistant referee regarding a possible goal that the referee did not see.
- The position of the ball is relevant when determining whether a goal has been scored, not the position of the goalkeeper.
- A goal should not be awarded if an outside agent (spectator, dog, etc.) has interfered with play prior to the ball entering the goal.
- A goal should not be awarded if the goalkeeper was incapacitated (injured or unable to play) immediately prior to the ball entering the goal.
- A goal should not be awarded if the Laws of the Game were violated by the attacking team immediately prior to the ball entering the goal.
- The referee may reverse his decision regarding the scoring of a goal as long as play has not yet been restarted.

LAW 11: Offside

Essential Facts Regarding Offside:

- You are offside if, in the opinion of the referee, you gain an advantage by being ahead of the ball when it is passed to you by a teammate, except if you are...
 - in your own 1/2 of the field.
 - even with or have at least 2 opponents between you and their goal line.
 - first to receive the ball from one of these 3 restarts: throw in, corner kick or goal kick.
 - not ahead of the ball at the moment it is played not when it is received. "The Moment of Judgment" (4 little words).
 - not interfering with play or an opponent. "Not Involved in Active Play" (5 little words).
- A player in an offside position is not eligible to participate in play.
- The punishment for being offside is an indirect free kick for the opposing team.
- The indirect free kick is taken from the location of the offside player.
- Being in an offside position is, by itself, not a violation of the Offside Law and should not be penalized.
- It is the referee's responsibility to determine whether or not, in his opinion, the player in an offside position has participated in the area of active play by
 - interfering with play,
 - interfering with an opponent, or
 - gaining an advantage by being in that position.
- The referee may or may not declare a violation of the Offside Law depending upon his judgment of the circumstances.

LAW 12: Fouls And Misconduct

Essential Facts Regarding Direct Free Kick Fouls:

The ten direct free kick fouls are divided into two groups.

- Seven require that the fouls be committed carelessly, recklessly, or with excessive force.
 - Kicking or attempting to kick an opponent
 - Striking or attempting to strike an opponent
 - Pushing an opponent
 - Charging an opponent
 - Tripping or attempting to trip an opponent
 - Jumping at an opponent
 - Tackles an opponent
- The other three require only that they be committed.
 - Spitting at an opponent
 - Holding an opponent
 - Handling the ball deliberately
 - The referee is the sole judge of whether an action is careless, reckless, or involves excessive force
 - The punishment for committing a direct free kick foul is a direct free kick for the opposing team at the point of the infraction. If a direct free kick foul is committed by a defender in his or her own penalty area, the opponents are awarded a penalty kick.

Essential Facts Regarding the Indirect Free Kick Fouls:

The seven indirect free kick fouls are divided into two groups.

- Four are committed by the goalkeeper.
 - Goalkeeper taking more than six seconds to release the ball into play while controlling the ball with his hands.
 - Goalkeeper, having released the ball into play, touching it again with his hands before it has been touched by another player.
 - Goalkeeper touching the ball with his hands on any occasion when a team mate has deliberately kicked the ball to him.
 - Goalkeeper touching the ball with his hands when a team-mate has thrown the ball in directly to him.
- Three may involve any player.
 - Plays in a dangerous manner.
 - Impedes the progress of an opponent.
 - Prevents the goalkeeper from releasing the ball from his hands.
- The punishment for committing an indirect free kick foul is an indirect free kick for the opponents at the point of the infraction. If the indirect free kick foul is committed by a defender inside his own goal area, the indirect free kick is taken at the nearest point on the goal area line that is parallel to the goal line.



Essential Facts Regarding Cautionable Offenses:

There are seven reasons a player may be cautioned and shown a yellow card.

- Unsporting behavior.
- Dissent, by word or action, with decisions of the referee.
- Persistently infringes the Laws of the Game.
- Delays the restart of play.
- Fails to respect the required distance during corner kicks or free kicks.
- Enters or re-enters the field of play without permission of the referee.
- Leaves the field of play without the permission of the referee.

Essential Facts Regarding Sending-Off Offenses:

There are seven reasons a player may be sent off the field and shown a red card.

- Serious foul play.
- Violent conduct.
- Spits at an opponent or any other person.
- Denies the opposing team a goal or an obvious goal-scoring opportunity by deliberately handling the ball.
- Denies an obvious goal-scoring opportunity to an opponent moving toward the player's goal by an offense punishable by a free kick or a penalty kick.
- Uses offensive, insulting, or abusive language and/or gestures.
- Receives a second caution in the same match.

LAW 13: Free Kicks

Essential Facts Regarding Free Kick:

- Direct free kicks are awarded for penal fouls and a goal may be scored directly against the opponents.
- Indirect free kicks are awarded for non penal fouls and certain technical infractions. After the ball is in play, it must touch or be played by a second player from either team before a goal can be scored.
- The opposing team must remain at least ten yards from the ball until the ball is kicked into play
- The ball is in play from a free kick once it has been kicked and has moved or, in the case of the defending team taking the kick from within their own penalty area, when the ball completely leaves the penalty area.
- The player taking the free kick may not play the ball a second time until it has been touched by another player. The penalty for violation is an indirect free kick for the opponents from the point of the infraction.



LAW 14: The Penalty Kick

Essential Facts Regarding Penalty Kick:

- A goal may be scored directly from a penalty kick.
- The kick is taken from the penalty mark located twelve yards from the goal line.
- The ball is in play once it has been kicked and moves forward.
- All players must be on the field of play, outside the penalty area, ten yards from the ball, and must stand behind the penalty mark, except for the kicker and the opposing goalkeeper.
- The defending goalkeeper remains on the goal line between the goalposts facing the kicker until the ball has been kicked.
- The kicker must wait for the referee's signal before taking the kick.
- The player taking the penalty kick may not play the ball twice in succession (penalty is an indirect free kick for the opposing team).
- For infringements of the Law by the defending team, the kick shall be retaken if a goal has not been scored.
- For infringements of the Law by the attacking team, except for the kicker playing the ball twice in succession, the kick shall be retaken if a goal was scored.
- For infringements of the Law by both teams, the kick shall be retaken regardless of the outcome.

LAW 15: The Throw-In

Essential Facts Regarding Throw-In:

- The throw-in shall be taken from the point at which the ball left the field.
- The opposing team players may be no closer than two yards from the thrower until the ball is put into play.
- The thrower must face the field and part of both feet must remain on or behind the touch line.
- The ball must be thrown with both hands from behind and over the head.
- The ball is in play as soon as it is both released and has entered the field of play.
- The thrower may not play the ball a second time in succession (penalty is an indirect free kick for the opposing team from the point of the infraction).
- If the ball is improperly thrown in, it shall be retaken by a player of the opposing team.
- A goal may not be scored directly from a throw-in.
- Exception to the Offside Law is permitted for the first person to receive the ball from a throw-in.



LAW 16: The Goal Kick

Essential Facts Regarding Goal Kick:

- The ball may be placed anywhere within the goal area.
- The ball is in play once it has been kicked beyond the penalty area.
- Opposing players must remain outside the penalty area until the ball is kicked into play beyond the penalty area.
- A goal may be scored directly from a goal kick, but only against the opposing team.
- The player taking the goal kick may not play the ball twice in succession (penalty is an indirect free kick for the opposing team).
- Exception to the Offside Law is permitted for the first person to receive the ball from a goal kick.

LAW 17: The Corner Kick

Essential Facts Regarding Corner Kick:

- The ball is placed within the corner arc at the nearest corner flag post.
- A goal may be scored directly from a corner kick.
- The ball is in play after it has been kicked and moves.
- Opposing players must remain ten yards from the ball until it is kicked into play.
- The corner flag must not be moved or removed during the taking of the corner kick.
- The kicker may not play the ball twice in succession (penalty is an indirect free kick for the opposing team).
- Exception to the Offside Law is permitted for the first person to receive the ball from a corner kick.



Appendix B: Line-Up Sheets



	Team Name: Team Number:	Field: Coach:	Date: Time:	433																																																																																										
<div style="display: flex; justify-content: space-between;"> <div style="width: 48%;"> <p style="text-align: center;">1st Quarter</p> <table style="width: 100%; border-collapse: collapse;"> <tr> <td style="width: 15%; text-align: center;">FORWARD</td> <td style="width: 15%; text-align: center;">CENTER FORWARD</td> <td style="width: 15%; text-align: center;">FORWARD</td> <td style="width: 15%; text-align: center;">FORWARD</td> <td style="width: 15%; text-align: center;">FORWARD</td> </tr> <tr> <td style="border: 1px solid black; height: 20px;"></td> <td style="border: 1px solid black; height: 20px;"></td> <td style="border: 1px solid black; height: 20px;"></td> <td style="border: 1px solid black; height: 20px;"></td> <td style="border: 1px solid black; height: 20px;"></td> </tr> <tr> <td style="text-align: center;">MIDFIELDER</td> <td style="text-align: center;">CENTER MIDFIELDER</td> <td style="text-align: center;">MIDFIELDER</td> <td style="text-align: center;">MIDFIELDER</td> <td style="text-align: center;">MIDFIELDER</td> </tr> <tr> <td style="border: 1px solid black; height: 20px;"></td> <td style="border: 1px solid black; height: 20px;"></td> <td style="border: 1px solid black; height: 20px;"></td> <td style="border: 1px solid black; height: 20px;"></td> <td style="border: 1px solid black; height: 20px;"></td> </tr> <tr> <td style="text-align: center;">L</td> <td style="text-align: center;">BACKS</td> <td style="text-align: center;">BACKS</td> <td style="text-align: center;">BACKS</td> <td style="text-align: center;">R</td> </tr> <tr> <td style="border: 1px solid black; height: 20px;"></td> <td style="border: 1px solid black; height: 20px;"></td> <td style="border: 1px solid black; height: 20px;"></td> <td style="border: 1px solid black; height: 20px;"></td> <td style="border: 1px solid black; height: 20px;"></td> </tr> <tr> <td style="border: 1px solid black; height: 20px;"></td> <td style="border: 1px solid black; height: 20px;"></td> <td style="border: 1px solid black; height: 20px;"></td> <td style="border: 1px solid black; height: 20px;"></td> <td style="border: 1px solid black; height: 20px;"></td> </tr> <tr> <td style="text-align: center;">BENCH</td> <td style="text-align: center;">GOALKEEPER</td> <td style="text-align: center;">GOALKEEPER</td> <td style="text-align: center;">GOALKEEPER</td> <td style="text-align: center;">GOALKEEPER</td> </tr> <tr> <td style="border: 1px solid black; height: 20px;"></td> <td style="border: 1px solid black; height: 20px;"></td> <td style="border: 1px solid black; height: 20px;"></td> <td style="border: 1px solid black; height: 20px;"></td> <td style="border: 1px solid black; height: 20px;"></td> </tr> </table> </div> <div style="width: 48%;"> <p style="text-align: center;">2nd Quarter</p> <table style="width: 100%; border-collapse: collapse;"> <tr> <td style="width: 15%; text-align: center;">FORWARD</td> <td style="width: 15%; text-align: center;">CENTER FORWARD</td> <td style="width: 15%; text-align: center;">FORWARD</td> <td style="width: 15%; text-align: center;">FORWARD</td> <td style="width: 15%; text-align: center;">FORWARD</td> </tr> <tr> <td style="border: 1px solid black; height: 20px;"></td> <td style="border: 1px solid black; height: 20px;"></td> <td style="border: 1px solid black; height: 20px;"></td> <td style="border: 1px solid black; height: 20px;"></td> <td style="border: 1px solid black; height: 20px;"></td> </tr> <tr> <td style="text-align: center;">MIDFIELDER</td> <td style="text-align: center;">CENTER MIDFIELDER</td> <td style="text-align: center;">MIDFIELDER</td> <td style="text-align: center;">MIDFIELDER</td> <td style="text-align: center;">MIDFIELDER</td> </tr> <tr> <td style="border: 1px solid black; height: 20px;"></td> <td style="border: 1px solid black; height: 20px;"></td> <td style="border: 1px solid black; height: 20px;"></td> <td style="border: 1px solid black; height: 20px;"></td> <td style="border: 1px solid black; height: 20px;"></td> </tr> <tr> <td style="text-align: center;">L</td> <td style="text-align: center;">BACKS</td> <td style="text-align: center;">BACKS</td> <td style="text-align: center;">BACKS</td> <td style="text-align: center;">R</td> </tr> <tr> <td style="border: 1px solid black; height: 20px;"></td> <td style="border: 1px solid black; height: 20px;"></td> <td style="border: 1px solid black; height: 20px;"></td> <td style="border: 1px solid black; height: 20px;"></td> <td style="border: 1px solid black; height: 20px;"></td> </tr> <tr> <td style="border: 1px solid black; height: 20px;"></td> <td style="border: 1px solid black; height: 20px;"></td> <td style="border: 1px solid black; height: 20px;"></td> <td style="border: 1px solid black; height: 20px;"></td> <td style="border: 1px solid black; height: 20px;"></td> </tr> <tr> <td style="text-align: center;">BENCH</td> <td style="text-align: center;">GOALKEEPER</td> <td style="text-align: center;">GOALKEEPER</td> <td style="text-align: center;">GOALKEEPER</td> <td style="text-align: center;">GOALKEEPER</td> </tr> <tr> <td style="border: 1px solid black; height: 20px;"></td> <td style="border: 1px solid black; height: 20px;"></td> <td style="border: 1px solid black; height: 20px;"></td> <td style="border: 1px solid black; height: 20px;"></td> <td style="border: 1px solid black; height: 20px;"></td> </tr> </table> </div> </div>					FORWARD	CENTER FORWARD	FORWARD	FORWARD	FORWARD						MIDFIELDER	CENTER MIDFIELDER	MIDFIELDER	MIDFIELDER	MIDFIELDER						L	BACKS	BACKS	BACKS	R											BENCH	GOALKEEPER	GOALKEEPER	GOALKEEPER	GOALKEEPER						FORWARD	CENTER FORWARD	FORWARD	FORWARD	FORWARD						MIDFIELDER	CENTER MIDFIELDER	MIDFIELDER	MIDFIELDER	MIDFIELDER						L	BACKS	BACKS	BACKS	R											BENCH	GOALKEEPER	GOALKEEPER	GOALKEEPER	GOALKEEPER					
FORWARD	CENTER FORWARD	FORWARD	FORWARD	FORWARD																																																																																										
MIDFIELDER	CENTER MIDFIELDER	MIDFIELDER	MIDFIELDER	MIDFIELDER																																																																																										
L	BACKS	BACKS	BACKS	R																																																																																										
BENCH	GOALKEEPER	GOALKEEPER	GOALKEEPER	GOALKEEPER																																																																																										
FORWARD	CENTER FORWARD	FORWARD	FORWARD	FORWARD																																																																																										
MIDFIELDER	CENTER MIDFIELDER	MIDFIELDER	MIDFIELDER	MIDFIELDER																																																																																										
L	BACKS	BACKS	BACKS	R																																																																																										
BENCH	GOALKEEPER	GOALKEEPER	GOALKEEPER	GOALKEEPER																																																																																										
<div style="display: flex; justify-content: space-between;"> <div style="width: 48%;"> <p style="text-align: center;">3rd Quarter</p> <table style="width: 100%; border-collapse: collapse;"> <tr> <td style="width: 15%; text-align: center;">FORWARD</td> <td style="width: 15%; text-align: center;">CENTER FORWARD</td> <td style="width: 15%; text-align: center;">FORWARD</td> <td style="width: 15%; text-align: center;">FORWARD</td> <td style="width: 15%; text-align: center;">FORWARD</td> </tr> <tr> <td style="border: 1px solid black; height: 20px;"></td> <td style="border: 1px solid black; height: 20px;"></td> <td style="border: 1px solid black; height: 20px;"></td> <td style="border: 1px solid black; height: 20px;"></td> <td style="border: 1px solid black; height: 20px;"></td> </tr> <tr> <td style="text-align: center;">MIDFIELDER</td> <td style="text-align: center;">CENTER MIDFIELDER</td> <td style="text-align: center;">MIDFIELDER</td> <td style="text-align: center;">MIDFIELDER</td> <td style="text-align: center;">MIDFIELDER</td> </tr> <tr> <td style="border: 1px solid black; height: 20px;"></td> <td style="border: 1px solid black; height: 20px;"></td> <td style="border: 1px solid black; height: 20px;"></td> <td style="border: 1px solid black; height: 20px;"></td> <td style="border: 1px solid black; height: 20px;"></td> </tr> <tr> <td style="text-align: center;">L</td> <td style="text-align: center;">BACKS</td> <td style="text-align: center;">BACKS</td> <td style="text-align: center;">BACKS</td> <td style="text-align: center;">R</td> </tr> <tr> <td style="border: 1px solid black; height: 20px;"></td> <td style="border: 1px solid black; height: 20px;"></td> <td style="border: 1px solid black; height: 20px;"></td> <td style="border: 1px solid black; height: 20px;"></td> <td style="border: 1px solid black; height: 20px;"></td> </tr> <tr> <td style="border: 1px solid black; height: 20px;"></td> <td style="border: 1px solid black; height: 20px;"></td> <td style="border: 1px solid black; height: 20px;"></td> <td style="border: 1px solid black; height: 20px;"></td> <td style="border: 1px solid black; height: 20px;"></td> </tr> <tr> <td style="text-align: center;">BENCH</td> <td style="text-align: center;">GOALKEEPER</td> <td style="text-align: center;">GOALKEEPER</td> <td style="text-align: center;">GOALKEEPER</td> <td style="text-align: center;">GOALKEEPER</td> </tr> <tr> <td style="border: 1px solid black; height: 20px;"></td> <td style="border: 1px solid black; height: 20px;"></td> <td style="border: 1px solid black; height: 20px;"></td> <td style="border: 1px solid black; height: 20px;"></td> <td style="border: 1px solid black; height: 20px;"></td> </tr> </table> </div> <div style="width: 48%;"> <p style="text-align: center;">4th Quarter</p> <table style="width: 100%; border-collapse: collapse;"> <tr> <td style="width: 15%; text-align: center;">FORWARD</td> <td style="width: 15%; text-align: center;">CENTER FORWARD</td> <td style="width: 15%; text-align: center;">FORWARD</td> <td style="width: 15%; text-align: center;">FORWARD</td> <td style="width: 15%; text-align: center;">FORWARD</td> </tr> <tr> <td style="border: 1px solid black; height: 20px;"></td> <td style="border: 1px solid black; height: 20px;"></td> <td style="border: 1px solid black; height: 20px;"></td> <td style="border: 1px solid black; height: 20px;"></td> <td style="border: 1px solid black; height: 20px;"></td> </tr> <tr> <td style="text-align: center;">MIDFIELDER</td> <td style="text-align: center;">CENTER MIDFIELDER</td> <td style="text-align: center;">MIDFIELDER</td> <td style="text-align: center;">MIDFIELDER</td> <td style="text-align: center;">MIDFIELDER</td> </tr> <tr> <td style="border: 1px solid black; height: 20px;"></td> <td style="border: 1px solid black; height: 20px;"></td> <td style="border: 1px solid black; height: 20px;"></td> <td style="border: 1px solid black; height: 20px;"></td> <td style="border: 1px solid black; height: 20px;"></td> </tr> <tr> <td style="text-align: center;">L</td> <td style="text-align: center;">BACKS</td> <td style="text-align: center;">BACKS</td> <td style="text-align: center;">BACKS</td> <td style="text-align: center;">R</td> </tr> <tr> <td style="border: 1px solid black; height: 20px;"></td> <td style="border: 1px solid black; height: 20px;"></td> <td style="border: 1px solid black; height: 20px;"></td> <td style="border: 1px solid black; height: 20px;"></td> <td style="border: 1px solid black; height: 20px;"></td> </tr> <tr> <td style="border: 1px solid black; height: 20px;"></td> <td style="border: 1px solid black; height: 20px;"></td> <td style="border: 1px solid black; height: 20px;"></td> <td style="border: 1px solid black; height: 20px;"></td> <td style="border: 1px solid black; height: 20px;"></td> </tr> <tr> <td style="text-align: center;">BENCH</td> <td style="text-align: center;">GOALKEEPER</td> <td style="text-align: center;">GOALKEEPER</td> <td style="text-align: center;">GOALKEEPER</td> <td style="text-align: center;">GOALKEEPER</td> </tr> <tr> <td style="border: 1px solid black; height: 20px;"></td> <td style="border: 1px solid black; height: 20px;"></td> <td style="border: 1px solid black; height: 20px;"></td> <td style="border: 1px solid black; height: 20px;"></td> <td style="border: 1px solid black; height: 20px;"></td> </tr> </table> </div> </div>					FORWARD	CENTER FORWARD	FORWARD	FORWARD	FORWARD						MIDFIELDER	CENTER MIDFIELDER	MIDFIELDER	MIDFIELDER	MIDFIELDER						L	BACKS	BACKS	BACKS	R											BENCH	GOALKEEPER	GOALKEEPER	GOALKEEPER	GOALKEEPER						FORWARD	CENTER FORWARD	FORWARD	FORWARD	FORWARD						MIDFIELDER	CENTER MIDFIELDER	MIDFIELDER	MIDFIELDER	MIDFIELDER						L	BACKS	BACKS	BACKS	R											BENCH	GOALKEEPER	GOALKEEPER	GOALKEEPER	GOALKEEPER					
FORWARD	CENTER FORWARD	FORWARD	FORWARD	FORWARD																																																																																										
MIDFIELDER	CENTER MIDFIELDER	MIDFIELDER	MIDFIELDER	MIDFIELDER																																																																																										
L	BACKS	BACKS	BACKS	R																																																																																										
BENCH	GOALKEEPER	GOALKEEPER	GOALKEEPER	GOALKEEPER																																																																																										
FORWARD	CENTER FORWARD	FORWARD	FORWARD	FORWARD																																																																																										
MIDFIELDER	CENTER MIDFIELDER	MIDFIELDER	MIDFIELDER	MIDFIELDER																																																																																										
L	BACKS	BACKS	BACKS	R																																																																																										
BENCH	GOALKEEPER	GOALKEEPER	GOALKEEPER	GOALKEEPER																																																																																										



	Team Name: Team Number:	Field: Coach:	Date: Time:	343																																																		
<div style="display: flex; justify-content: space-between;"> <div style="width: 48%;"> <p style="text-align: center;">1st Quarter</p> <table style="width: 100%; border-collapse: collapse;"> <tr> <td style="width: 15%; text-align: center;">L</td> <td style="width: 15%;">FORWARD</td> <td style="width: 15%;">CENTER FORWARD</td> <td style="width: 15%;">FORWARD</td> <td style="width: 15%; text-align: center;">R</td> </tr> <tr> <td></td> <td></td> <td style="text-align: center;">MIDFIELDERS</td> <td></td> <td></td> </tr> <tr> <td></td> <td style="text-align: center;">BACK</td> <td style="text-align: center;">SWEEPER</td> <td style="text-align: center;">BACK</td> <td></td> </tr> <tr> <td></td> <td></td> <td style="text-align: center;">GOALKEEPER</td> <td></td> <td></td> </tr> <tr> <td style="text-align: center;">BENCH</td> <td></td> <td></td> <td></td> <td></td> </tr> </table> </div> <div style="width: 48%;"> <p style="text-align: center;">2nd Quarter</p> <table style="width: 100%; border-collapse: collapse;"> <tr> <td style="width: 15%; text-align: center;">L</td> <td style="width: 15%;">FORWARD</td> <td style="width: 15%;">CENTER FORWARD</td> <td style="width: 15%;">FORWARD</td> <td style="width: 15%; text-align: center;">R</td> </tr> <tr> <td></td> <td></td> <td style="text-align: center;">MIDFIELDERS</td> <td></td> <td></td> </tr> <tr> <td></td> <td style="text-align: center;">BACK</td> <td style="text-align: center;">SWEEPER</td> <td style="text-align: center;">BACK</td> <td></td> </tr> <tr> <td></td> <td></td> <td style="text-align: center;">GOALKEEPER</td> <td></td> <td></td> </tr> <tr> <td style="text-align: center;">BENCH</td> <td></td> <td></td> <td></td> <td></td> </tr> </table> </div> </div>					L	FORWARD	CENTER FORWARD	FORWARD	R			MIDFIELDERS				BACK	SWEEPER	BACK				GOALKEEPER			BENCH					L	FORWARD	CENTER FORWARD	FORWARD	R			MIDFIELDERS				BACK	SWEEPER	BACK				GOALKEEPER			BENCH				
L	FORWARD	CENTER FORWARD	FORWARD	R																																																		
		MIDFIELDERS																																																				
	BACK	SWEEPER	BACK																																																			
		GOALKEEPER																																																				
BENCH																																																						
L	FORWARD	CENTER FORWARD	FORWARD	R																																																		
		MIDFIELDERS																																																				
	BACK	SWEEPER	BACK																																																			
		GOALKEEPER																																																				
BENCH																																																						
<div style="display: flex; justify-content: space-between;"> <div style="width: 48%;"> <p style="text-align: center;">3rd Quarter</p> <table style="width: 100%; border-collapse: collapse;"> <tr> <td style="width: 15%; text-align: center;">L</td> <td style="width: 15%;">FORWARD</td> <td style="width: 15%;">CENTER FORWARD</td> <td style="width: 15%;">FORWARD</td> <td style="width: 15%; text-align: center;">R</td> </tr> <tr> <td></td> <td></td> <td style="text-align: center;">MIDFIELDERS</td> <td></td> <td></td> </tr> <tr> <td></td> <td style="text-align: center;">BACK</td> <td style="text-align: center;">SWEEPER</td> <td style="text-align: center;">BACK</td> <td></td> </tr> <tr> <td></td> <td></td> <td style="text-align: center;">GOALKEEPER</td> <td></td> <td></td> </tr> <tr> <td style="text-align: center;">BENCH</td> <td></td> <td></td> <td></td> <td></td> </tr> </table> </div> <div style="width: 48%;"> <p style="text-align: center;">4th Quarter</p> <table style="width: 100%; border-collapse: collapse;"> <tr> <td style="width: 15%; text-align: center;">L</td> <td style="width: 15%;">FORWARD</td> <td style="width: 15%;">CENTER FORWARD</td> <td style="width: 15%;">FORWARD</td> <td style="width: 15%; text-align: center;">R</td> </tr> <tr> <td></td> <td></td> <td style="text-align: center;">MIDFIELDERS</td> <td></td> <td></td> </tr> <tr> <td></td> <td style="text-align: center;">BACK</td> <td style="text-align: center;">SWEEPER</td> <td style="text-align: center;">BACK</td> <td></td> </tr> <tr> <td></td> <td></td> <td style="text-align: center;">GOALKEEPER</td> <td></td> <td></td> </tr> <tr> <td style="text-align: center;">BENCH</td> <td></td> <td></td> <td></td> <td></td> </tr> </table> </div> </div>					L	FORWARD	CENTER FORWARD	FORWARD	R			MIDFIELDERS				BACK	SWEEPER	BACK				GOALKEEPER			BENCH					L	FORWARD	CENTER FORWARD	FORWARD	R			MIDFIELDERS				BACK	SWEEPER	BACK				GOALKEEPER			BENCH				
L	FORWARD	CENTER FORWARD	FORWARD	R																																																		
		MIDFIELDERS																																																				
	BACK	SWEEPER	BACK																																																			
		GOALKEEPER																																																				
BENCH																																																						
L	FORWARD	CENTER FORWARD	FORWARD	R																																																		
		MIDFIELDERS																																																				
	BACK	SWEEPER	BACK																																																			
		GOALKEEPER																																																				
BENCH																																																						



	Team Name: Team Number:	Field: Coach:	Date: Time:	424
<div style="display: flex; justify-content: space-between;"> <div style="width: 20%;"> <p>L</p> <p>WING</p> <p>STRIKER</p> <p>STRIKER</p> <p>WING</p> </div> <div style="width: 20%;"> <p>MID FIELDERS</p> <p>MID FIELDERS</p> </div> <div style="width: 20%;"> <p>R</p> <p>BACKS</p> <p>BACKS</p> <p>WING</p> </div> <div style="width: 20%; text-align: center;"> <p>1st Quarter</p> <p>GOALKEEPER</p> </div> <div style="width: 20%; text-align: center;"> <p>2nd Quarter</p> <p>GOALKEEPER</p> </div> </div>				
<div style="display: flex; justify-content: space-between;"> <div style="width: 20%;"> <p>L</p> <p>WING</p> <p>STRIKER</p> <p>STRIKER</p> <p>WING</p> </div> <div style="width: 20%;"> <p>MID FIELDERS</p> <p>MID FIELDERS</p> </div> <div style="width: 20%;"> <p>R</p> <p>BACKS</p> <p>BACKS</p> <p>WING</p> </div> <div style="width: 20%; text-align: center;"> <p>3rd Quarter</p> <p>GOALKEEPER</p> </div> <div style="width: 20%; text-align: center;"> <p>4th Quarter</p> <p>GOALKEEPER</p> </div> </div>				



	Team Name: Team Number:	Field: Coach:	Date: Time:
334			
<div style="display: flex; justify-content: space-between;"> <div style="width: 20%;">WING</div> <div style="width: 20%;">STRIKER</div> <div style="width: 20%;">WING</div> </div> <div style="display: flex; justify-content: space-between; margin-top: 10px;"> <div style="width: 20%;">MIDFIELDER</div> <div style="width: 20%;">CENTER</div> <div style="width: 20%;">MIDFIELDER</div> </div> <div style="display: flex; justify-content: space-between; margin-top: 10px;"> <div style="width: 20%;">BACK</div> <div style="width: 20%;">SWEEPER</div> <div style="width: 20%;">BACK</div> </div> <div style="display: flex; justify-content: space-between; margin-top: 10px;"> <div style="width: 20%;">L</div> <div style="width: 20%;"></div> <div style="width: 20%;">R</div> </div>	<div style="display: flex; justify-content: space-between;"> <div style="width: 20%;">WING</div> <div style="width: 20%;">STRIKER</div> <div style="width: 20%;">WING</div> </div> <div style="display: flex; justify-content: space-between; margin-top: 10px;"> <div style="width: 20%;">MIDFIELDER</div> <div style="width: 20%;">CENTER</div> <div style="width: 20%;">MIDFIELDER</div> </div> <div style="display: flex; justify-content: space-between; margin-top: 10px;"> <div style="width: 20%;">BACK</div> <div style="width: 20%;">SWEEPER</div> <div style="width: 20%;">BACK</div> </div> <div style="display: flex; justify-content: space-between; margin-top: 10px;"> <div style="width: 20%;">L</div> <div style="width: 20%;"></div> <div style="width: 20%;">R</div> </div>	<div style="display: flex; justify-content: space-between;"> <div style="width: 20%;">WING</div> <div style="width: 20%;">STRIKER</div> <div style="width: 20%;">WING</div> </div> <div style="display: flex; justify-content: space-between; margin-top: 10px;"> <div style="width: 20%;">MIDFIELDER</div> <div style="width: 20%;">CENTER</div> <div style="width: 20%;">MIDFIELDER</div> </div> <div style="display: flex; justify-content: space-between; margin-top: 10px;"> <div style="width: 20%;">BACK</div> <div style="width: 20%;">SWEEPER</div> <div style="width: 20%;">BACK</div> </div> <div style="display: flex; justify-content: space-between; margin-top: 10px;"> <div style="width: 20%;">L</div> <div style="width: 20%;"></div> <div style="width: 20%;">R</div> </div>	<div style="display: flex; justify-content: space-between;"> <div style="width: 20%;">WING</div> <div style="width: 20%;">STRIKER</div> <div style="width: 20%;">WING</div> </div> <div style="display: flex; justify-content: space-between; margin-top: 10px;"> <div style="width: 20%;">MIDFIELDER</div> <div style="width: 20%;">CENTER</div> <div style="width: 20%;">MIDFIELDER</div> </div> <div style="display: flex; justify-content: space-between; margin-top: 10px;"> <div style="width: 20%;">BACK</div> <div style="width: 20%;">SWEEPER</div> <div style="width: 20%;">BACK</div> </div> <div style="display: flex; justify-content: space-between; margin-top: 10px;"> <div style="width: 20%;">L</div> <div style="width: 20%;"></div> <div style="width: 20%;">R</div> </div>
1st Quarter			
<div style="display: flex; justify-content: space-between;"> <div style="width: 20%;">WING</div> <div style="width: 20%;">STRIKER</div> <div style="width: 20%;">WING</div> </div> <div style="display: flex; justify-content: space-between; margin-top: 10px;"> <div style="width: 20%;">MIDFIELDER</div> <div style="width: 20%;">CENTER</div> <div style="width: 20%;">MIDFIELDER</div> </div> <div style="display: flex; justify-content: space-between; margin-top: 10px;"> <div style="width: 20%;">BACK</div> <div style="width: 20%;">SWEEPER</div> <div style="width: 20%;">BACK</div> </div> <div style="display: flex; justify-content: space-between; margin-top: 10px;"> <div style="width: 20%;">L</div> <div style="width: 20%;"></div> <div style="width: 20%;">R</div> </div>	<div style="display: flex; justify-content: space-between;"> <div style="width: 20%;">WING</div> <div style="width: 20%;">STRIKER</div> <div style="width: 20%;">WING</div> </div> <div style="display: flex; justify-content: space-between; margin-top: 10px;"> <div style="width: 20%;">MIDFIELDER</div> <div style="width: 20%;">CENTER</div> <div style="width: 20%;">MIDFIELDER</div> </div> <div style="display: flex; justify-content: space-between; margin-top: 10px;"> <div style="width: 20%;">BACK</div> <div style="width: 20%;">SWEEPER</div> <div style="width: 20%;">BACK</div> </div> <div style="display: flex; justify-content: space-between; margin-top: 10px;"> <div style="width: 20%;">L</div> <div style="width: 20%;"></div> <div style="width: 20%;">R</div> </div>	<div style="display: flex; justify-content: space-between;"> <div style="width: 20%;">WING</div> <div style="width: 20%;">STRIKER</div> <div style="width: 20%;">WING</div> </div> <div style="display: flex; justify-content: space-between; margin-top: 10px;"> <div style="width: 20%;">MIDFIELDER</div> <div style="width: 20%;">CENTER</div> <div style="width: 20%;">MIDFIELDER</div> </div> <div style="display: flex; justify-content: space-between; margin-top: 10px;"> <div style="width: 20%;">BACK</div> <div style="width: 20%;">SWEEPER</div> <div style="width: 20%;">BACK</div> </div> <div style="display: flex; justify-content: space-between; margin-top: 10px;"> <div style="width: 20%;">L</div> <div style="width: 20%;"></div> <div style="width: 20%;">R</div> </div>	<div style="display: flex; justify-content: space-between;"> <div style="width: 20%;">WING</div> <div style="width: 20%;">STRIKER</div> <div style="width: 20%;">WING</div> </div> <div style="display: flex; justify-content: space-between; margin-top: 10px;"> <div style="width: 20%;">MIDFIELDER</div> <div style="width: 20%;">CENTER</div> <div style="width: 20%;">MIDFIELDER</div> </div> <div style="display: flex; justify-content: space-between; margin-top: 10px;"> <div style="width: 20%;">BACK</div> <div style="width: 20%;">SWEEPER</div> <div style="width: 20%;">BACK</div> </div> <div style="display: flex; justify-content: space-between; margin-top: 10px;"> <div style="width: 20%;">L</div> <div style="width: 20%;"></div> <div style="width: 20%;">R</div> </div>
2nd Quarter			
<div style="display: flex; justify-content: space-between;"> <div style="width: 20%;">WING</div> <div style="width: 20%;">STRIKER</div> <div style="width: 20%;">WING</div> </div> <div style="display: flex; justify-content: space-between; margin-top: 10px;"> <div style="width: 20%;">MIDFIELDER</div> <div style="width: 20%;">CENTER</div> <div style="width: 20%;">MIDFIELDER</div> </div> <div style="display: flex; justify-content: space-between; margin-top: 10px;"> <div style="width: 20%;">BACK</div> <div style="width: 20%;">SWEEPER</div> <div style="width: 20%;">BACK</div> </div> <div style="display: flex; justify-content: space-between; margin-top: 10px;"> <div style="width: 20%;">L</div> <div style="width: 20%;"></div> <div style="width: 20%;">R</div> </div>	<div style="display: flex; justify-content: space-between;"> <div style="width: 20%;">WING</div> <div style="width: 20%;">STRIKER</div> <div style="width: 20%;">WING</div> </div> <div style="display: flex; justify-content: space-between; margin-top: 10px;"> <div style="width: 20%;">MIDFIELDER</div> <div style="width: 20%;">CENTER</div> <div style="width: 20%;">MIDFIELDER</div> </div> <div style="display: flex; justify-content: space-between; margin-top: 10px;"> <div style="width: 20%;">BACK</div> <div style="width: 20%;">SWEEPER</div> <div style="width: 20%;">BACK</div> </div> <div style="display: flex; justify-content: space-between; margin-top: 10px;"> <div style="width: 20%;">L</div> <div style="width: 20%;"></div> <div style="width: 20%;">R</div> </div>	<div style="display: flex; justify-content: space-between;"> <div style="width: 20%;">WING</div> <div style="width: 20%;">STRIKER</div> <div style="width: 20%;">WING</div> </div> <div style="display: flex; justify-content: space-between; margin-top: 10px;"> <div style="width: 20%;">MIDFIELDER</div> <div style="width: 20%;">CENTER</div> <div style="width: 20%;">MIDFIELDER</div> </div> <div style="display: flex; justify-content: space-between; margin-top: 10px;"> <div style="width: 20%;">BACK</div> <div style="width: 20%;">SWEEPER</div> <div style="width: 20%;">BACK</div> </div> <div style="display: flex; justify-content: space-between; margin-top: 10px;"> <div style="width: 20%;">L</div> <div style="width: 20%;"></div> <div style="width: 20%;">R</div> </div>	<div style="display: flex; justify-content: space-between;"> <div style="width: 20%;">WING</div> <div style="width: 20%;">STRIKER</div> <div style="width: 20%;">WING</div> </div> <div style="display: flex; justify-content: space-between; margin-top: 10px;"> <div style="width: 20%;">MIDFIELDER</div> <div style="width: 20%;">CENTER</div> <div style="width: 20%;">MIDFIELDER</div> </div> <div style="display: flex; justify-content: space-between; margin-top: 10px;"> <div style="width: 20%;">BACK</div> <div style="width: 20%;">SWEEPER</div> <div style="width: 20%;">BACK</div> </div> <div style="display: flex; justify-content: space-between; margin-top: 10px;"> <div style="width: 20%;">L</div> <div style="width: 20%;"></div> <div style="width: 20%;">R</div> </div>
3rd Quarter			
<div style="display: flex; justify-content: space-between;"> <div style="width: 20%;">WING</div> <div style="width: 20%;">STRIKER</div> <div style="width: 20%;">WING</div> </div> <div style="display: flex; justify-content: space-between; margin-top: 10px;"> <div style="width: 20%;">MIDFIELDER</div> <div style="width: 20%;">CENTER</div> <div style="width: 20%;">MIDFIELDER</div> </div> <div style="display: flex; justify-content: space-between; margin-top: 10px;"> <div style="width: 20%;">BACK</div> <div style="width: 20%;">SWEEPER</div> <div style="width: 20%;">BACK</div> </div> <div style="display: flex; justify-content: space-between; margin-top: 10px;"> <div style="width: 20%;">L</div> <div style="width: 20%;"></div> <div style="width: 20%;">R</div> </div>	<div style="display: flex; justify-content: space-between;"> <div style="width: 20%;">WING</div> <div style="width: 20%;">STRIKER</div> <div style="width: 20%;">WING</div> </div> <div style="display: flex; justify-content: space-between; margin-top: 10px;"> <div style="width: 20%;">MIDFIELDER</div> <div style="width: 20%;">CENTER</div> <div style="width: 20%;">MIDFIELDER</div> </div> <div style="display: flex; justify-content: space-between; margin-top: 10px;"> <div style="width: 20%;">BACK</div> <div style="width: 20%;">SWEEPER</div> <div style="width: 20%;">BACK</div> </div> <div style="display: flex; justify-content: space-between; margin-top: 10px;"> <div style="width: 20%;">L</div> <div style="width: 20%;"></div> <div style="width: 20%;">R</div> </div>	<div style="display: flex; justify-content: space-between;"> <div style="width: 20%;">WING</div> <div style="width: 20%;">STRIKER</div> <div style="width: 20%;">WING</div> </div> <div style="display: flex; justify-content: space-between; margin-top: 10px;"> <div style="width: 20%;">MIDFIELDER</div> <div style="width: 20%;">CENTER</div> <div style="width: 20%;">MIDFIELDER</div> </div> <div style="display: flex; justify-content: space-between; margin-top: 10px;"> <div style="width: 20%;">BACK</div> <div style="width: 20%;">SWEEPER</div> <div style="width: 20%;">BACK</div> </div> <div style="display: flex; justify-content: space-between; margin-top: 10px;"> <div style="width: 20%;">L</div> <div style="width: 20%;"></div> <div style="width: 20%;">R</div> </div>	<div style="display: flex; justify-content: space-between;"> <div style="width: 20%;">WING</div> <div style="width: 20%;">STRIKER</div> <div style="width: 20%;">WING</div> </div> <div style="display: flex; justify-content: space-between; margin-top: 10px;"> <div style="width: 20%;">MIDFIELDER</div> <div style="width: 20%;">CENTER</div> <div style="width: 20%;">MIDFIELDER</div> </div> <div style="display: flex; justify-content: space-between; margin-top: 10px;"> <div style="width: 20%;">BACK</div> <div style="width: 20%;">SWEEPER</div> <div style="width: 20%;">BACK</div> </div> <div style="display: flex; justify-content: space-between; margin-top: 10px;"> <div style="width: 20%;">L</div> <div style="width: 20%;"></div> <div style="width: 20%;">R</div> </div>
4th Quarter			